



Enhancing life safety  
at every fire door

# Product catalogue



# Our mission is to enhance life safety at every fire door.

Because we believe that every  
building should **protect the life within it.**

Rutland develops, produces and supplies first-rate fire door hardware and components. But we also advise and inform on best practice, and take part in conversations in the industry on how to make buildings safer, because life safety is important for all of us.

Over the years, we've gained considerable industry expertise and knowledge – expertise that we will readily share with you, whether you are a door manufacturer, a reseller or a specifier. It's our job to help you to select the right fire door hardware for specific situations.

It's our mission to provide you with exceptional support, whether it's advice on ensuring compliance, or guidance on adjusting a door closer. **This is the Rutland way.**

If you can't find what you're looking for in our catalogue, do get in touch, we'd be happy to hear from you.







## What our customers say about Rutland

“ I’m totally in awe at your commitment to the greater cause and putting your products through this level of testing. Congrats to you and the team. I wouldn’t hesitate recommending Rutland to any of our customers who we can influence.

“ It’s your aftersales support and technical help that really sets you apart and that’s why we’ve used you more this year. It’s easy to pick the phone up and talk to you.

“ The reliability and technical knowledge of the staff and the quality of the product are 10 out of 10. The products are always being updated and kept in line with current standards.

“ For a layman like me, this was very easy to fit. Very good instructions with template. I got slightly stuck, so called Rutland and their tech team were very helpful.

“ We’re happy to have such a high-spec, aesthetically appealing and technologically advantageous closer as our main closer.

↑  
Our dedicated  
Customer Happiness team

## CONTENTS

## The Rutland Range

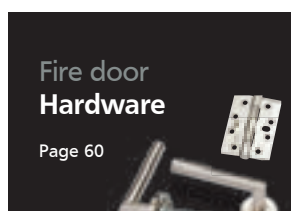
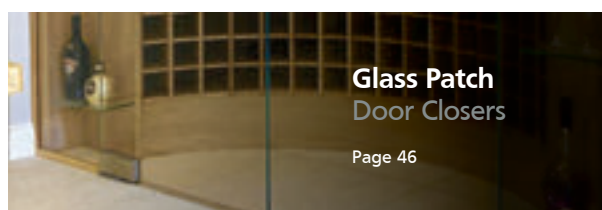
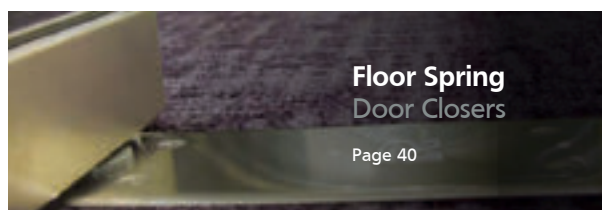
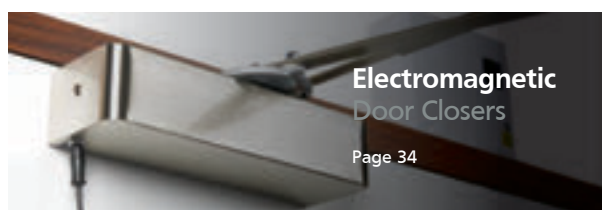
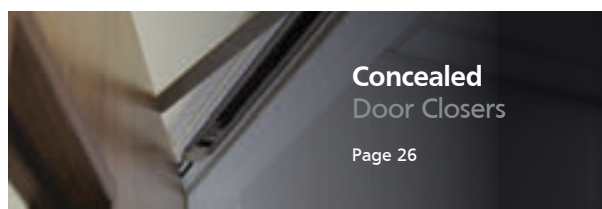
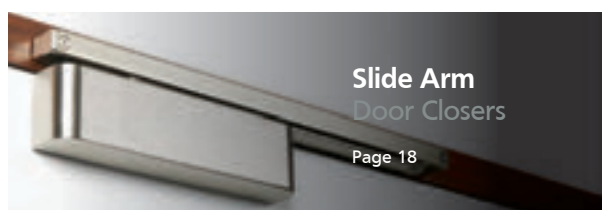
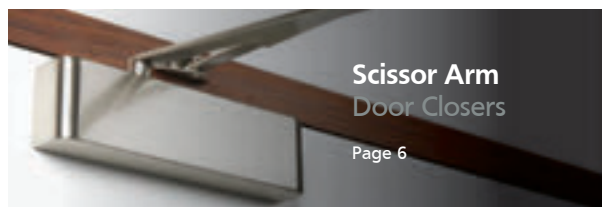

|   |   |
|---|---|
| <b>Scissor Arm Door Closers Overview.....</b> | <b>6</b>                                      |
| TS.3204                                       | EN 3 Fixed Power adjustable by template.....8 |
| TS.4204                                       | EN 2-4 Power adjustable by spring.....10      |
| TS.5204                                       | EN 2-4 Power adjustable by spring.....12      |
| TS.9205                                       | EN 2-5 Power adjustable by spring.....14      |
| TS.9206                                       | EN 2-6 Power adjustable by spring.....16      |

|   |  |
|---|--|
| <b>Slide Arm Door Closers Overview.....</b> | <b>18</b>  |
| TS.24                                       | Rack & Pinion, power adjustable EN2-4 by spring.....20 |
| TS.11204                                    | Cam Action, Power adjustable EN 2-4 by spring.....22   |
| TS.11205                                    | Cam Action, Power adjustable EN 2-5 by spring.....24   |

|   |  |
|---|--|
| <b>Concealed Slide Arm Door Closers Overview.....</b> | <b>26</b>  |
| ITS.11204   | Cam action, power adjustable EN2-4 by spring.....28        |
| ITS.11205   | Cam action, power adjustable EN2-5 by spring.....30        |
| ITS.11204.3.5   | Cam action (micro-rail) power adjustable size EN2-4.....32 |
| ITS.H3  | Heel Closer.....33   |

|   |  |
|---|--|
| <b>Electromagnetic Door Closers Overview.....</b> | <b>34</b>  |
| RESPONDER 24                                      | Emag Door Closer, fixed power EN4.....36                 |
| TS.FIRETRAK.114                                   | Emag Slide Arm Door Closer power adjustable EN2-4.....38 |
| TS.FIRETRAK.115                                   | Emag Slide Arm Door Closer power adjustable EN2-5.....39 |

|   |                                    |
|---|------------------------------------|
| <b>Floor Spring Closers Overview.....</b> | <b>40</b>                          |
| TS.7003+7004                              | Fixed power size EN3 or EN4.....42 |
| TS.7104                                   | Power adjustable EN 1-4.....44     |
| TS.7306                                   | Power adjustable EN 3-6.....45     |

|   |   |
|---|---|
| <b>Glass Patch Door Closers Overview.....</b> | <b>46</b>   |
| GP3   | Glass Patch Door Closer fixed power size EN3.....48   |
| GP35  | Glass Patch Door Closer power adjustable EN3-5.....49 |

|                             |           |
|-----------------------------|-----------|
| <b>Transom Closers.....</b> | <b>50</b> |
|-----------------------------|-----------|

|                             |           |
|-----------------------------|-----------|
| <b>Door Restrictor.....</b> | <b>51</b> |
|-----------------------------|-----------|

|                         |           |
|-------------------------|-----------|
| <b>Accessories.....</b> | <b>52</b> |
|-------------------------|-----------|

|   |   |
|---|---|
| <b>Fire &amp; Security Door Hardware.....</b> | <b>60</b>                                       |
| RDL.DL  | DIN Standard Dead Lock Size 55/60mm.....60      |
| RDL.ESL                                       | DIN Standard Euro Sash Lock Size 55/60mm.....61 |
| RDL.BL  | DIN Bathroom Lock Size 55/60mm.....62           |
| RDL.L   | DIN Standard Latch Size 55/60mm.....63          |
| RL.RTD  | Return to Door Lever Handle.....64              |
| RL.STB  | T-Bar Lever Handle.....64                       |
| RL.M  | Mitred Lever Handle.....64                      |
| RH.DBSh                                       | Dog Bolt Security Hinge.....65                  |

|                            |              |
|----------------------------|--------------|
| <b>Product Codes .....</b> | <b>66-86</b> |
|----------------------------|--------------|

|  |              |
|--|--------------|
| <b>Resources: Events, Installation &amp; Guides.....</b> | <b>88-95</b> |
|--|--------------|

|   |              |
|---|--------------|
| <b>Colours / Finish &amp; Design Style.....</b> | <b>96-97</b> |
|---|--------------|

|                  |           |
|------------------|-----------|
| <b>FAQs.....</b> | <b>98</b> |
|------------------|-----------|

|                 |           |
|-----------------|-----------|
| <b>NBS.....</b> | <b>99</b> |
|-----------------|-----------|



# Scissor Arm Door Closers

Surface-mounted door closers  
with a reliable rack and pinion  
closing mechanism.

Available in a variety of finishes, with  
delayed action and back check options.



### TS.3204 PAGE 8

- Fixed power size EN3/4, adjustable by template
- CE, UKCA marked
- Easy to use template fitting instructions



### TS.4204 PAGE 10

- Variable power adjustment EN2-4
- CE, UKCA marked
- Back check and delayed action features are as standard on this model
- Easy to use template fitting instructions



### TS.5204 PAGE 12

- Variable Power adjustment EN2-4
- CE, UKCA marked and UL listed
- Assists BS8300 (Suitable for Doc M Contracts)
- Available with delayed action and back check
- Easy to use template fitting instructions



### TS.9205 PAGE 14

- Variable power size EN 2-5
- CE, UKCA marked and UL listed
- Assists BS8300 (Suitable for Doc M Contracts)
- Available with delayed action and back check
- Easy to use template fitting instructions



### TS.9206 PAGE 16

- Variable power size EN 2-6, adjustable by spring
- CE, UKCA marked and UL listed
- Available with back check and delayed action
- Renown for high efficiency, immense torque and ultimate control
- Easy to use template fitting instructions

SCISSOR ARM DOOR CLOSERS

# TS.3204





SCISSOR ARM DOOR CLOSERS

# TS.3204

The TS.3204 is a Certifire approved and ideal choice for mid-range contracts, with power size 3/4, adjustable by template, and optional back check.

- Available in Silver, Satin Nickel, Polished Nickel, Polished Brass White for next day delivery
- Easy to read instructions, saving over 12 minutes of fitting time
- Corrosion Grade 3 - Recommended for internal use



3rd Party Certification



Opening Angle 180°



Two-Stage Speed Regulation



Guarantee



Max Door Width



Max Door Weight



| Product Features               | TS.3204            |
|--------------------------------|--------------------|
| Delayed Action                 | -                  |
| Back Check                     | TS.3204BC          |
| Opening Angle                  | 180°               |
| Fig.1 Pull Side Door Width     | 300-1100mm         |
| Fig.66 Push Side Door Width    | 470-950mm          |
| Max Door Weight                | <80kg              |
| Power Adjustment               | By Template        |
| Hold Open (not for fire doors) | o                  |
| Dimensions (including cover)   | W250 x H66 x D43mm |

| Certification Compliance                   |   |
|--|---|
| Certifire (Not applicable for BC versions) | ✓ |
| UKCA                                       | ✓ |
| CE   | ✓ |
| BS EN 1154                                 | ✓ |
| BS EN 1634                                 | ✓ |
| UL10C                                      | ✓ |
| UL228                                      | ✓ |
| ANSI BHMA                                  | - |
| IFCC                                       | ✓ |
| EPD 3.09E+01 kg CO <sub>2</sub> eq         | ✓ |

**Key:** ✓ Yes - No o Option

Finishes

See page 96 for more detail



SE Silver



SNP Satin Nickel



PNP Polished Nickel



WH White



PVD Polished Brass



1720



Approved Product CF 6018



1812

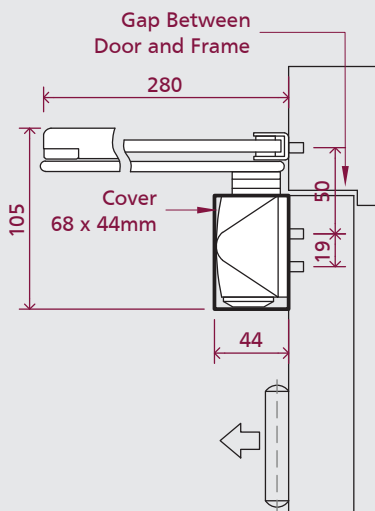

Cover 68 x 224mm

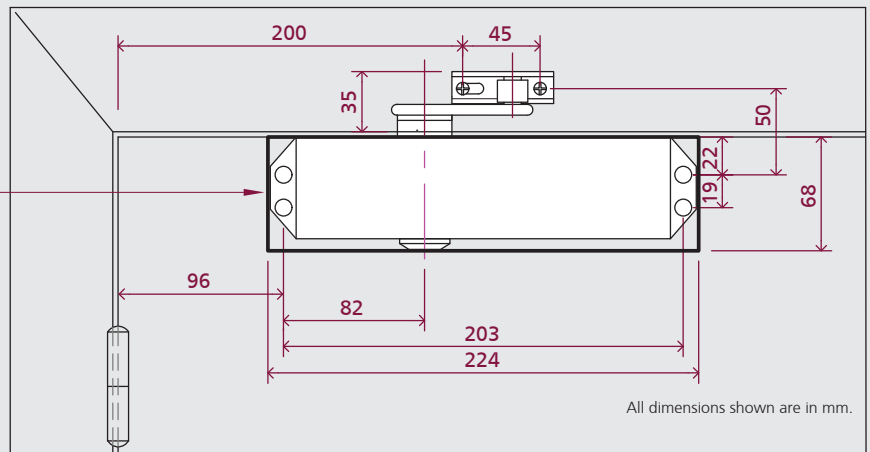

All dimensions shown are in mm.

For fitting instructions see website

SCISSOR ARM DOOR CLOSERS

# TS.4204



SCISSOR ARM DOOR CLOSERS

# TS.4204

Certifire approved EN2-4 Rack and Pinion contract door close, adjustable by spring, and delayed action and back check as standard.

- Easy to read instructions, saving over 12 minutes of fitting time
- Corrosion Grade 3 – Recommended for internal use



3rd Party Certification



Opening Angle 180°



Two-Stage Speed Regulation



Guarantee

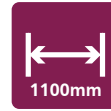

Max Door Width



Max Door Weight



| Product Features                   | TS.4204            |
|------------------------------------|--------------------|
| Delayed Action                     | ✓                  |
| Back Check                         | ✓                  |
| Opening Angle                      | 180°               |
| Fig.1 Pull Side Door Width         | 340-1100mm         |
| Fig.66 Push Side Door Width        | 485-1100mm         |
| Max Door Weight                    | <80kg              |
| Power Adjustment                   | By Spring          |
| Hold Open (not for fire doors)     | ◦                  |
| Dimensions (including cover)       | W250 x H65 x D53mm |
| Certification Compliance           |                    |
| Certifire                          | ✓                  |
| UKCA                               | ✓                  |
| CE                                 | ✓                  |
| BS EN 1154                         | ✓                  |
| BS EN 1634                         | ✓                  |
| UL10C                              | -                  |
| UL228                              | -                  |
| ANSI BHMA                          | -                  |
| IFCC                               | ✓                  |
| EPD 3.09E+01 kg CO <sub>2</sub> eq | ✓                  |
| <b>Key:</b> ✓ Yes - No ◦ Option    |                    |

Finishes

See page 96 for more detail



SE Silver



SNP Satin Nickel



PNP Polished Nickel

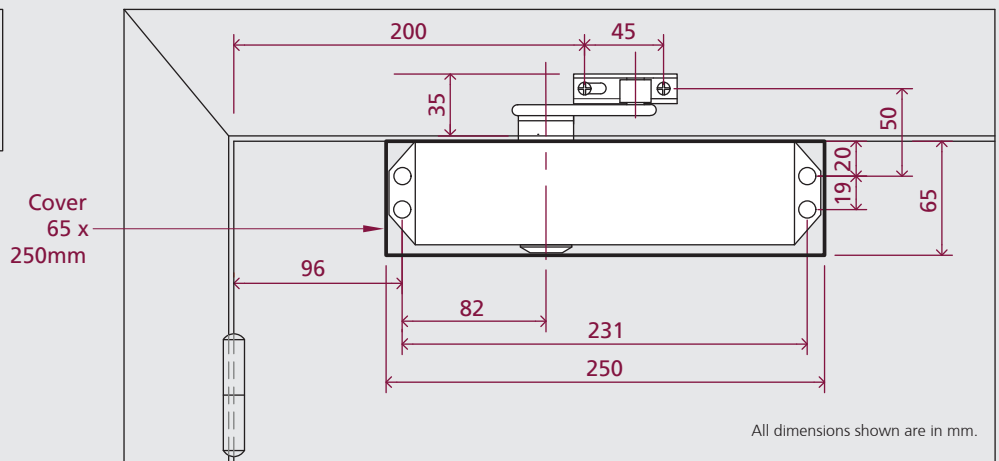
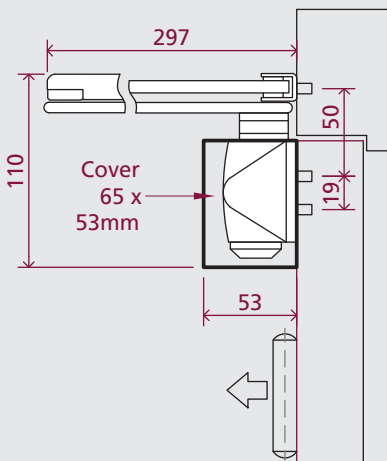

All dimensions shown are in mm.

For fitting instructions see website

SCISSOR ARM DOOR CLOSERS

# TS.5204



Townlands Hospital – Henley on Thames

SCISSOR ARM DOOR CLOSERS

# TS.5204

The TS.5204 is an easily adjustable and economical door closer that is power adjustable by spring, with back check as standard, and optional delayed action.

- Assists BS8300 meaning easy use for the less able.
- Available in Silver, Satin Nickel, Polished Nickel, Polished Brass, Antique Brass and Black for next day delivery
- Universal application meaning it can be fitted in Standard, Parallel arm or Transom fitting position



3rd Party Certification



Opening Angle 180°



Two-Stage Speed Regulation



Guarantee



Max Door Width 1100mm



Max Door Weight 80Kg



**Finishes**

See page 96 for more detail



SE Silver



SNP Satin Nickel



PNP Polished Nickel



PVD Polished Brass



AB Antique Brass



BK Black



1720



Approved Product CF 6018

| Product Features                   | TS.5204            |
|------------------------------------|--------------------|
| Delayed Action                     | TS.5204DABC        |
| Back Check                         | TS.5204BC          |
| Opening Angle                      | 180°               |
| Fig.1 Pull Side Door Width         | 360-1100mm         |
| Fig.66 Push Side Door Width        | 485-985mm          |
| Fig. 1 BS8300 Door Width           | 920mm              |
| Fig.66 BS8300 Door Width           | 887mm              |
| Max Door Weight                    | <80kg              |
| Power Adjustment                   | By Spring          |
| Hold Open (not for fire doors)     | o                  |
| Dimensions (including cover)       | W258 x H68 x D45mm |
| <b>Certification Compliance</b>    |                    |
| Certifire                          | ✓                  |
| UKCA                               | ✓                  |
| CE                                 | ✓                  |
| BS EN 1154                         | ✓                  |
| BS EN 1634                         | ✓                  |
| UL10C                              | ✓                  |
| UL228                              | ✓                  |
| ANSI BHMA                          | -                  |
| IFCC                               | ✓                  |
| EPD 3.09E+01 kg CO <sub>2</sub> eq | ✓                  |
| <b>Key:</b> ✓ Yes - No o Option    |                    |

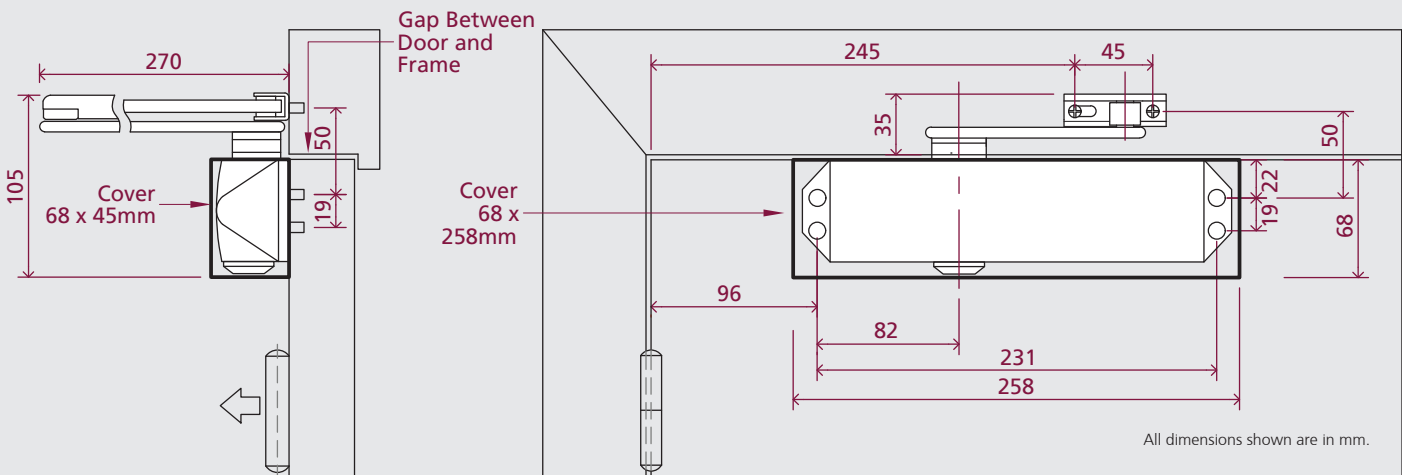

For fitting instructions see website

SCISSOR ARM DOOR CLOSERS

# TS.9205



The Shard, London UK



SCISSOR ARM DOOR CLOSERS

# TS.9205

Designed to last, the TS.9205 is a popular and highly efficient door closer with both optional back check and delayed action, and assisting BS8300.

- Power Adjustable EN2-5.
- 15 Finishes available for next day delivery, including an anti-corrosion Marine316.
- Slimline body & cover with only 40mm projection.
- EN2-5 parallel arm an optional using short parallel arm bracket (Product Code: PAB.1)



3rd Party Certification



Opening Angle 180°



Two-Stage Speed Regulation



Guarantee



Max Door Width



Max Door Weight



**Finishes**

See page 96 for more detail



| Product Features                   | TS.9205            |
|------------------------------------|--------------------|
| Delayed Action                     | ✓                  |
| Back Check                         | ✓                  |
| Opening Angle                      | 180° (Fig 1)       |
| Fig.1 Pull Side Door Width         | 390-1250mm         |
| Fig.66 Push Side Door Width        | 390-1100mm         |
| Fig.1 BS8300 Min Door Width        | 835mm              |
| Fig.66 BS8300 Min Door Width       | 728mm              |
| Max Door Weight                    | <110kg             |
| Power Adjustment                   | By Spring          |
| Hold Open (not for fire doors)     | ◦                  |
| Dimensions (including cover)       | W269 x H69 x D40mm |
| <b>Certification Compliance</b>    |                    |
| Certifire                          | ✓                  |
| UKCA                               | ✓                  |
| CE                                 | ✓                  |
| BS EN 1154                         | ✓                  |
| BS EN 1634                         | ✓                  |
| UL10C                              | ✓                  |
| UL228                              | ✓                  |
| ANSI BHMA                          | -                  |
| IFCC                               | ✓                  |
| EPD 3.09E+01 kg CO <sub>2</sub> eq | ✓                  |

**Key:** ✓ Yes - No ◦ Option

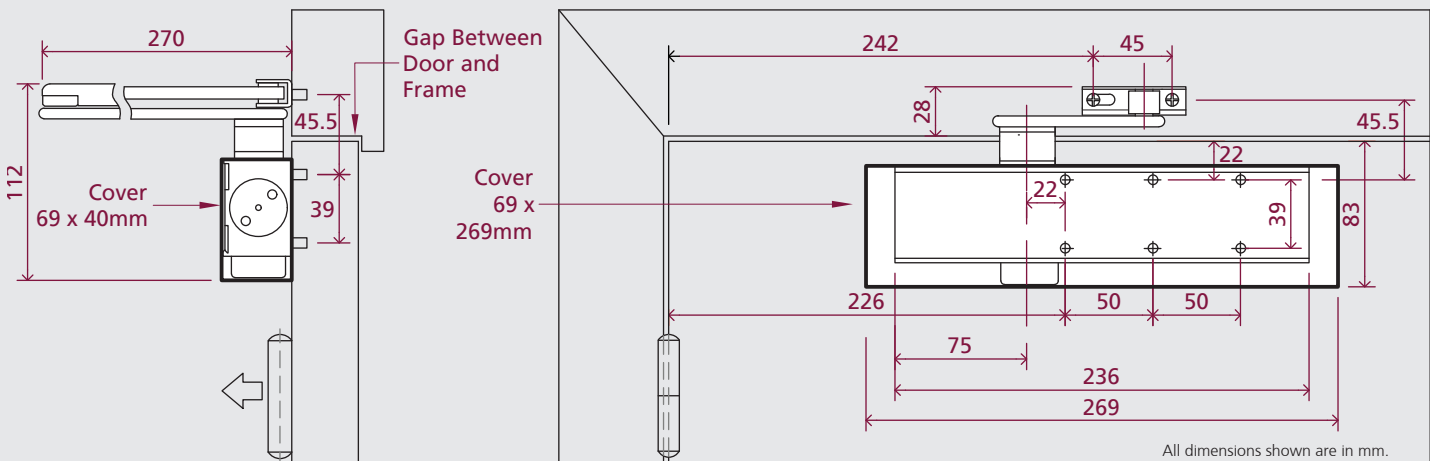

For fitting instructions see website

SCISSOR ARM DOOR CLOSERS

# TS.9206





SCISSOR ARM DOOR CLOSERS

# TS.9206

Ideal for heavy usage, the TS.9206 is power adjustable by spring size 2-6, has a unique slimline appearance and comes with back check and delayed action as standard.

- Suitable for use on doors up to 1400mm wide
- 35 Year Guarantee
- Available in 4 different finishes for next day delivery



3rd Party Certification



Opening Angle 180°



Two-Stage Speed Regulation



Guarantee

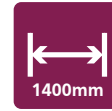

Max Door Width



Max Door Weight



| Product Features               | TS.9206            |
|--------------------------------|--------------------|
| Delayed Action                 | ✓                  |
| Back Check                     | ✓                  |
| Opening Angle                  | 180°               |
| Fig.1 Pull Side Door Width     | 415-1400mm         |
| Fig.66 Push Side Door Width    | 490-1250mm         |
| Fig.1 BS8300 Min Door Width    | 835mm              |
| Fig.66 BS8300 Min Door Width   | 728mm              |
| Max Door Weight                | <120kg             |
| Power Adjustment               | By Spring          |
| Hold Open (not for fire doors) | ◦                  |
| Dimensions (including cover)   | W307 x H77 x D47mm |

| Certification Compliance           |   |
|------------------------------------|---|
| Certifire                          | - |
| UKCA                               | ✓ |
| CE                                 | ✓ |
| BS EN 1154                         | ✓ |
| BS EN 1634                         | ✓ |
| UL10C                              | - |
| UL228                              | - |
| ANSI BHMA                          | - |
| IFCC                               | ✓ |
| EPD 3.09E+01 kg CO <sub>2</sub> eq | ✓ |

Key: ✓ Yes - No ◦ Option

Finishes

See page 96 for more detail



SE Silver



SNP Satin Nickel



PNP Polished Nickel



M Marine 316

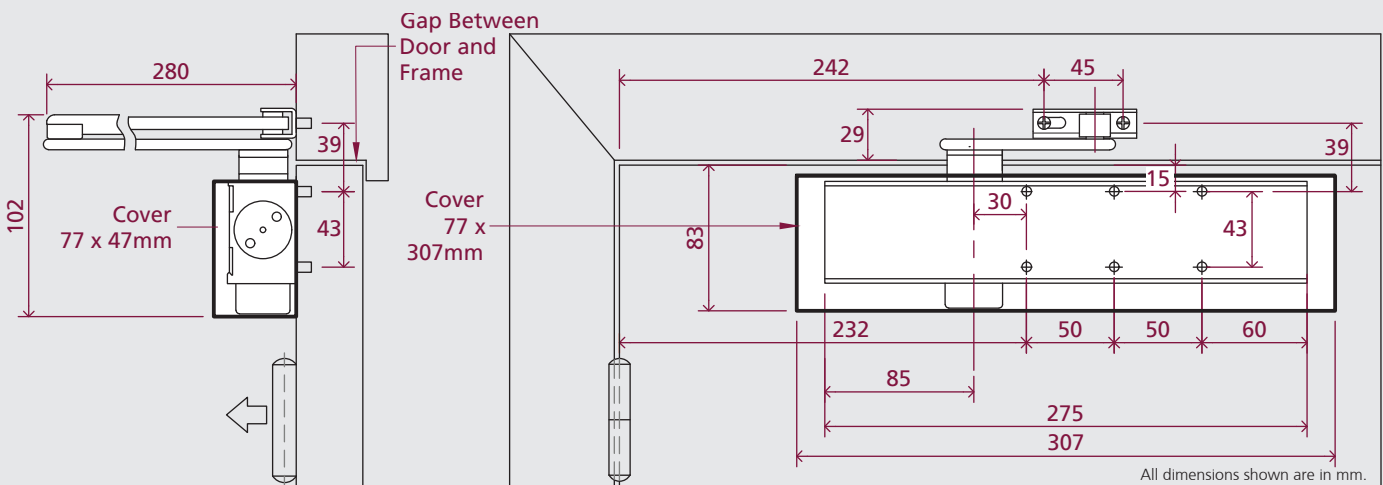

For fitting instructions see website



# Slide Arm Door Closers

Slim and stylish surface-mounted door closers with minimal projections of no more than 43mm from the door.

Available in a variety of finishes, with delayed action and back check options.



## TS.24 PAGE 20

- Variable power size EN 2-4
- CE, UKCA marked
- Ezykam™ motion technology for immense control throughout the full opening and closing cycle of the door
- Easy to use template fitting instructions



## TS.11204 PAGE 22

- Variable power size EN 2-4
- CE, UKCA marked and UL listed
- Renown for high efficiency & ease of opening
- Easy to use template fitting instructions



## TS.11205 PAGE 24

- Variable power size EN 2-5
- CE, UKCA marked and UL listed
- Available with back check and adjustable delayed action
- Easy to use template fitting instructions

SLIDE ARM DOOR CLOSERS

# TS.24



SLIDE ARM DOOR CLOSER

# TS.24

With a rack+pinion mechanism giving fine control throughout both the opening and closing cycle, the Rutland TS.24 slide arm door closer has an opening angle of up to 180° and is power adjustable by spring, power size 2-4.

- 180° Opening Angle
- Total projection of 40mm from the door
- Available in Silver, Satin Nickel & White for next day delivery



3rd Party Certification



Opening Angle 180°



Two-Stage Speed Regulation



Guarantee

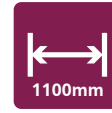

Max Door Width 1100mm



Max Door Weight 80Kg



**Finishes**

See page 96 for more detail



SE Silver



SNP Satin Nickel



WH White

| Product Features                   | TS.24              |
|------------------------------------|--------------------|
| Delayed Action                     | -                  |
| Back Check                         | -                  |
| Opening Angle                      | 180°               |
| Fig.1 Pull Side Door Width         | 490-1100mm         |
| Fig.66 Push Side Door Width        | 490-1100mm         |
| Max Door Weight                    | 80kg               |
| Power Adjustment                   | By Spring          |
| Hold Open (not for fire doors)     | o                  |
| Dimensions (including cover)       | W269 x H69 x D40mm |
| <b>Certification Compliance</b>    |                    |
| Certifire                          | -                  |
| UKCA                               | ✓                  |
| CE                                 | ✓                  |
| BS EN 1154                         | ✓                  |
| BS EN 1634                         | ✓                  |
| UL10C                              | -                  |
| UL228                              | -                  |
| ANSI BHMA                          | -                  |
| IFCC                               | ✓                  |
| EPD 3.09E+01 kg CO <sub>2</sub> eq | ✓                  |
| <b>Key:</b> ✓ Yes - No o Option    |                    |

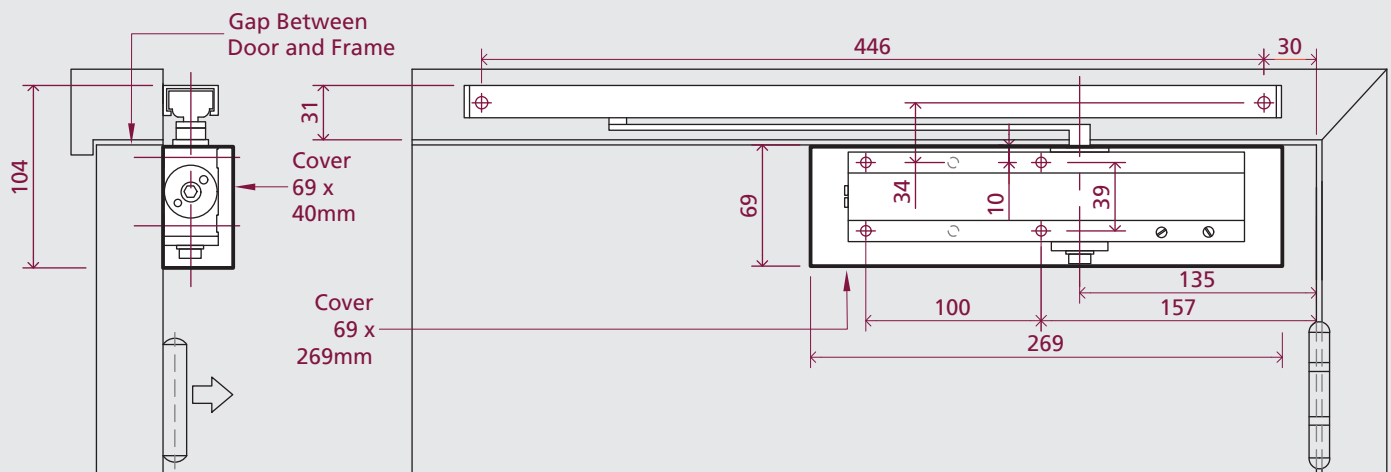

All dimensions shown are in mm.

For fitting instructions see website

SLIDE ARM DOOR CLOSERS

# TS.11204



SLIDE ARM DOOR CLOSERS

# TS.11204

Being renowned for its high efficiency and ease of opening with a cam action mechanism, the TS.11204 is a Certifire approved door closer for both push and pull side applications. This surface fixed slide arm door closer has a slimline projection of only 39mm, and is power adjustable by spring, power size 2-4.

- Universal fitting – can be fitted in pull-side, push-side or transom fitting position
- Option of Square (Satin Nickel only) or Semi-Radius cover
- Available in Silver, Satin Nickel, Polished Nickel, Polished Brass, Black & Antique Brass for next day delivery



3rd Party Certification



Opening Angle 110°



Two-Stage Speed Regulation

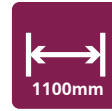

Max Door Width 1100mm



Max Door Weight 80Kg



Guarantee



Assists BS8300

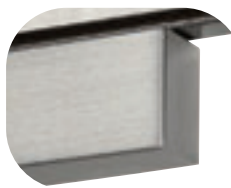

Square Cover (SQ)



Semi Radius Cover (SR)

Finishes

See page 96 for more detail



SE Silver



SNP Satin Nickel



PNP Polished Nickel



PVD Polished Brass



AB Antique Brass



BK Black



| Product Features                    | TS.11204           |
|-------------------------------------|--------------------|
| Delayed Action                      | -                  |
| Back Check (Cushion stop available) | -                  |
| Opening Angle                       | 110°               |
| Fig.1 Pull Side Door Width          | 575-1100mm         |
| Fig.66 Push Side Door Width         | 575-1100mm         |
| Fig.1 BS8300 Min Door Width         | 857mm              |
| Max Door Weight                     | <80kg              |
| Power Adjustment                    | By Spring          |
| Hold Open (not for fire doors)      | -                  |
| Dimensions (including cover)        | W253 x H61 x D39mm |
| Certification Compliance            |                    |
| Certifire                           | ✓                  |
| UKCA                                | ✓                  |
| CE                                  | ✓                  |
| BS EN 1154                          | ✓                  |
| BS EN 1634                          | ✓                  |
| UL10C                               | -                  |
| UL228                               | ✓                  |
| ANSI BHMA                           | -                  |
| IFCC                                | ✓                  |
| EPD 3.09E+01 kg CO <sub>2</sub> eq  | ✓                  |
| Key: ✓ Yes - No ◦ Option            |                    |

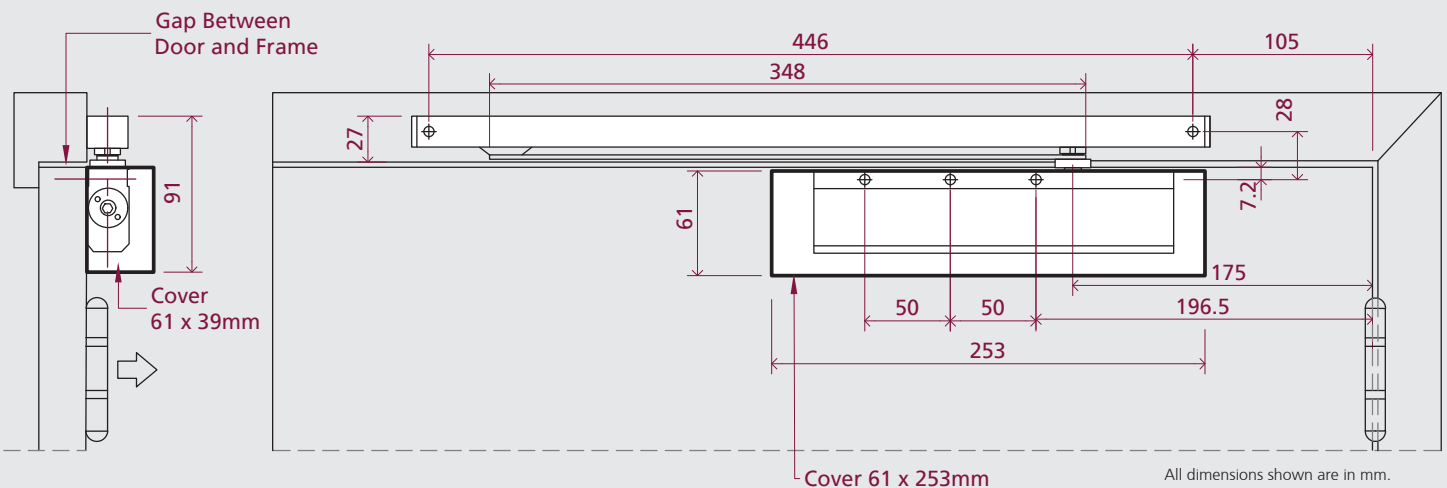

For fitting instructions see website

SLIDE ARM DOOR CLOSERS

# TS.11205

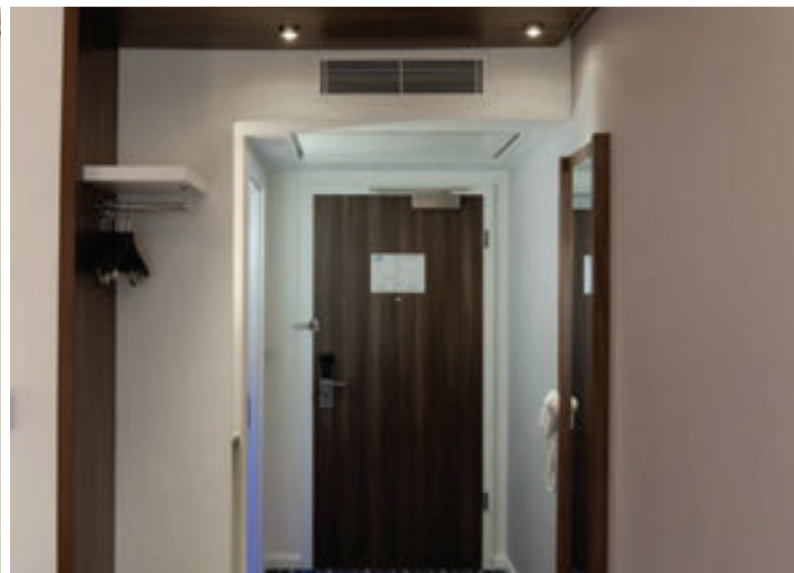



SLIDE ARM DOOR CLOSERS

# TS.11205

The Rutland Certifire approved TS.11205 Cam Action door closer gets the perfect balance between ease of opening for the less able whilst having enough power to close doors up to 1250mm wide and 110kg, making it ideal for contracts where requirements include meeting Doc M and BS8300 (or formerly DDA).

- Available with optional back check and delayed action
- Power Adjustable by spring, size 2-5
- Available in Silver, Satin Nickel, Polished Nickel, Polished Brass & Black for next day delivery

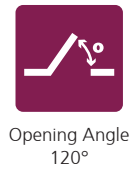
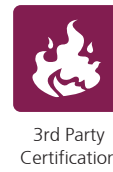

**Finishes**

See page 96 for more detail



| Product Features               | TS.11205             |
|--------------------------------|----------------------|
| Opening Angle                  | 120°                 |
| Fig.1 Pull Side Door Width     | 575-1250mm           |
| Fig.66 Push Side Door Width    | 575-1250mm           |
| Fig.1 BS8300 Min Door Width    | EN3-757mm, EN4-743mm |
| Max Door Weight                | <110kg               |
| Power Adjustment               | By Spring            |
| Hold Open (not for fire doors) | o                    |
| Dimensions (including cover)   | W257 x H68 x D43mm   |

| Certification Compliance           |   |
|------------------------------------|---|
| Certifire                          | ✓ |
| UKCA                               | ✓ |
| CE                                 | ✓ |
| BS EN 1154                         | ✓ |
| BS EN 1634                         | ✓ |
| UL10C                              | - |
| UL228                              | ✓ |
| ANSI BHMA                          | - |
| IFCC                               | ✓ |
| EPD 3.09E+01 kg CO <sub>2</sub> eq | ✓ |

**Key:** ✓ Yes - No o Option

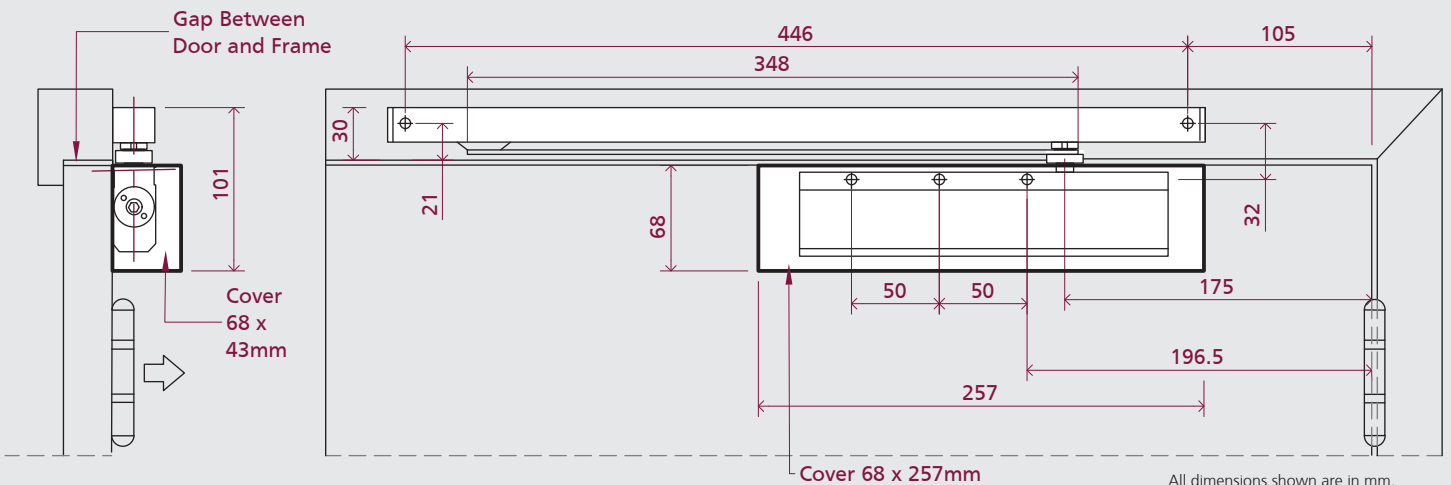

For fitting instructions see website



# Concealed Slide Arm Door Closers

Highly efficient with a slimline mechanism, some being suitable for 44mm thick doors.

Available in a variety of finishes.



**ITS.11204** PAGE 28

- Variable power adjustment EN2-4
- CE, UKCA marked and UL listed
- Easy to use template fitting instructions
- Suitable for both 44 and 54mm thick doors



**ITS.11205** PAGE 30

- Variable power adjustment EN2-5
- Engineered from exceptional high quality components
- Easy to use template fitting instructions
- Suitable for 54mm+ thick doors



**ITS.11204.3.5** PAGE 32

- Variable power adjustment EN2-4
- Assists Document M and BS 8300
- Easy to use template fitting instructions
- Designed for hollow profile frames, but can be used in solid frames



**ITS.H3** PAGE 33

- Fixed power size EN3
- Available with 'hold-open' or 'non-hold-open'
- Adjustable closing and latching speed

CONCEALED SLIDE ARM DOOR CLOSERS

# ITS.11204

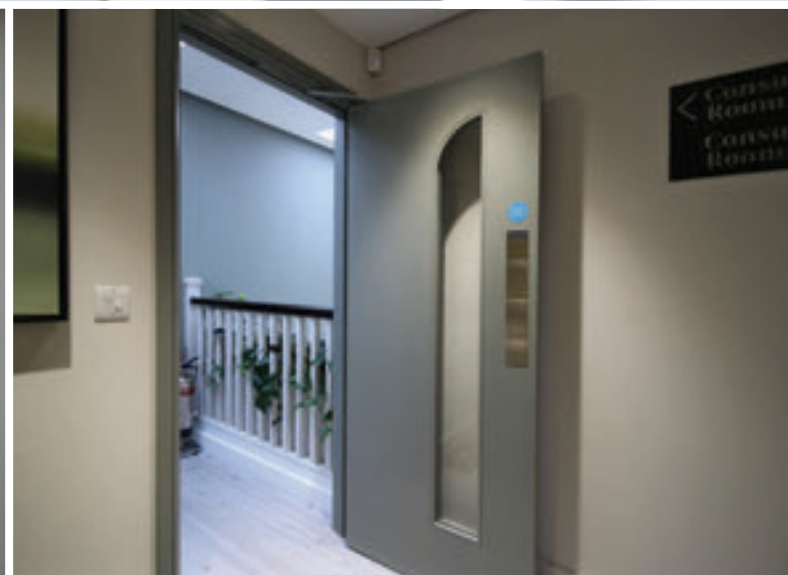

CONCEALED SLIDE ARM DOOR CLOSERS

# ITS.11204

Renowned for its slimline mechanism (32mm body) and suitability for assisting BS8300 requirements, the Rutland ITS.11204 Cam Action door closer has been successfully fire tested numerous times in 44mm fire doors, making it a perfect door closer for situations where minimal aesthetics are required.



3rd Party Certification



Opening Angle 110°



Two-Stage Speed Regulation



Guarantee

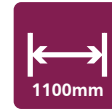

Max Door Width 1100mm



Max Door Weight 130Kg

- Certifire Approved
- Power Adjustable by spring, size 2-4
- Suitable for both 44 and 54mm thick doors
- Available in Silver, Satin Nickel, Polished Nickel, Polished Brass & Antique Brass for next day delivery

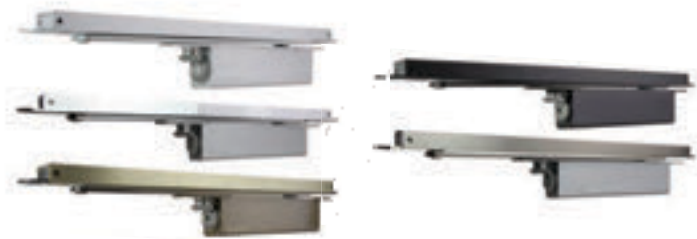

Intumescent kit (IP.114)



| Product Features               | ITS.11204          |
|--------------------------------|--------------------|
| Delayed Action                 | -                  |
| Back Check                     | -                  |
| Opening Angle                  | 110°               |
| Fig.1 Pull Side Door Width     | 595-1100mm         |
| Fig.66 Push Side Door Width    | 595-1100mm         |
| Fig.1 BS8300 Min Door Width    | 835mm              |
| Max Door Weight                | <130kg             |
| Power Adjustment               | By Spring          |
| Hold Open (not for fire doors) | o                  |
| Dimensions                     | W243 x H52 x D32mm |

| Certification Compliance           |   |
|------------------------------------|---|
| Certifire                          | ✓ |
| UKCA                               | ✓ |
| CE                                 | ✓ |
| BS EN 1154                         | ✓ |
| BS EN 1634                         | ✓ |
| UL10C                              | - |
| UL228                              | ✓ |
| ANSI BHMA                          | - |
| IFCC                               | ✓ |
| EPD 3.09E+01 kg CO <sub>2</sub> eq | ✓ |

**Key:** ✓ Yes - No o Option

Finishes

See page 96 for more detail

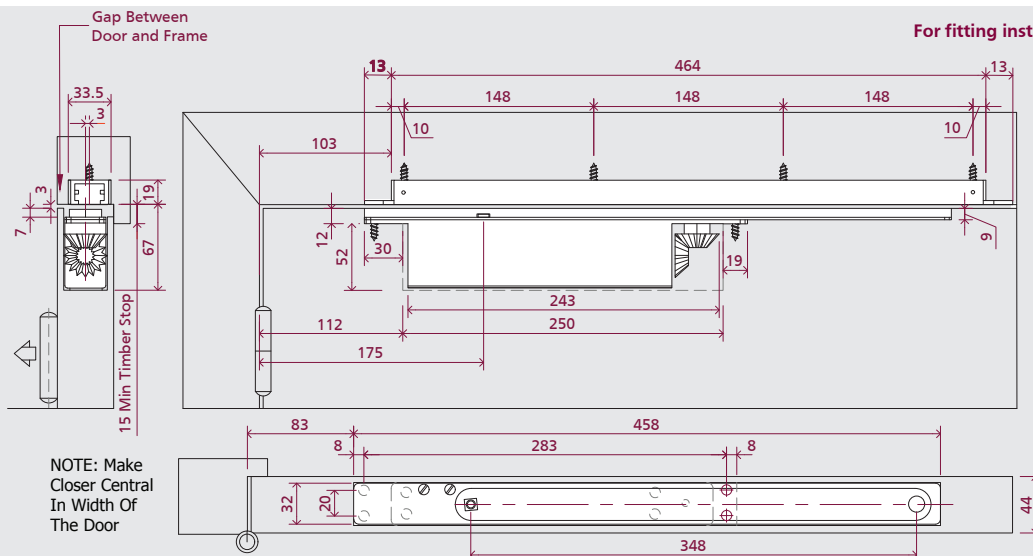
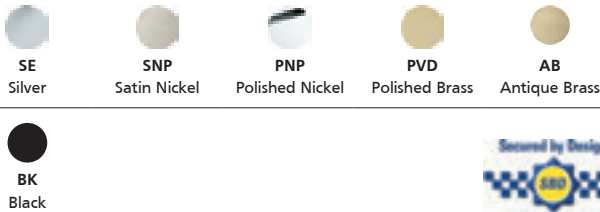

CONCEALED SLIDE ARM DOOR CLOSERS

# ITS.11205

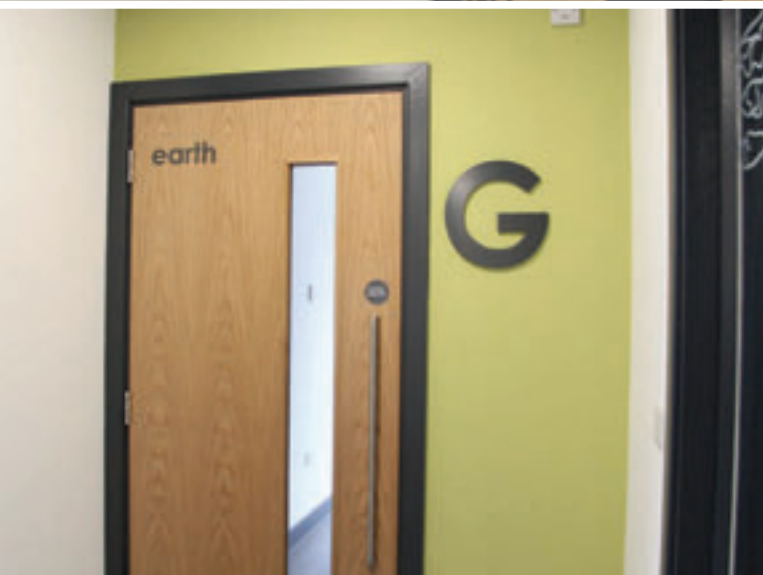

CONCEALED SLIDE ARM DOOR CLOSERS

# ITS.11205

Renowned for its high efficiency, the Rutland ITS.11205 cam action door closer has size 2-5 power adjustment and is suitable for use in doors 54mm thick. With its cam and roller mechanism, and ease of opening, this closer is suitable for assisting Document M and BS8300 requirements.



3rd Party Certification



Opening Angle 120°



Two-Stage Speed Regulation



Guarantee



Max Door Width 1250mm



Max Door Weight 180Kg

- Fully concealed when the door is closed
- Power Adjustable by spring, size 2-5
- Available in Silver, Satin Nickel, Polished Nickel, Polished Brass & Black for next day delivery



Intumescent kit (IP.115)

**Finishes**

See page 96 for more detail



| Product Features                   | ITS.11205          |
|------------------------------------|--------------------|
| Delayed Action                     | -                  |
| Back Check                         | -                  |
| Opening Angle                      | 120°               |
| Fig.1 Pull Side Door Width         | 595-1250mm         |
| Fig.66 Push Side Door Width        | 595-1250mm         |
| Fig.1 BS8300 Min Door Width        | 835mm              |
| Max Door Weight                    | <180kg             |
| Power Adjustment                   | By Spring          |
| Hold Open (not for fire doors)     | o                  |
| Dimensions                         | W243 x H58 x D42mm |
| Certification Compliance           |                    |
| Certifire                          | -                  |
| UKCA                               | ✓                  |
| CE                                 | -                  |
| BS EN 1154                         | ✓                  |
| BS EN 1634                         | ✓                  |
| UL10C                              | -                  |
| UL228                              | ✓                  |
| ANSI BHMA                          | -                  |
| IFCC                               | ✓                  |
| EPD 3.09E+01 kg CO <sub>2</sub> eq | ✓                  |
| <b>Key:</b> ✓ Yes - No o Option    |                    |

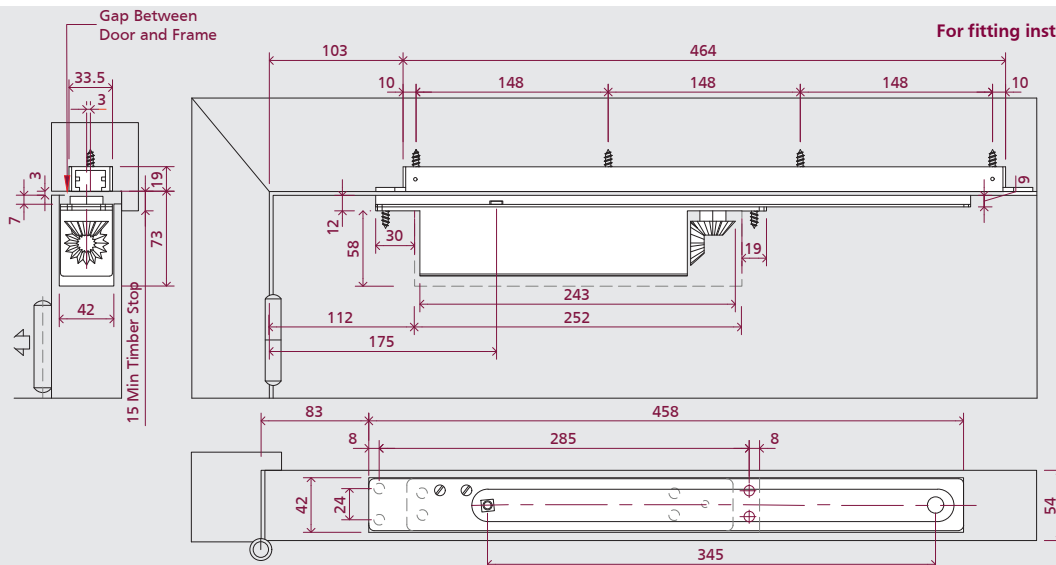

For fitting instructions see website

All dimensions shown are in mm.

CONCEALED SLIDE ARM DOOR CLOSERS

# ITS.11204.3.5

Renowned for its slimline mechanism (32mm body) and suitability for assisting BS8300 requirements, the key difference between the ITS.11204 and the ITS.11204.3.5 is the slimline micro rail that comes as standard on the ITS.11204.3.5, allowing the concealed closer to be used in door frames of thinner and more shallow widths.

- Slim micro rail of 20 x 30mm
- Power Adjustable by spring, size 2-4
- Available in Silver & Satin Nickel for next day delivery
- Designed for hollow profile frames, but can be used in solid timber frames



Opening Angle  
110°



Two-Stage  
Speed Regulation



Guarantee



Max Door  
Width



Max Door  
Weight



Intumescent  
kit (IP.114M)



| Product Features                    | ITS.11204.3.5      |
|-------------------------------------|--------------------|
| Delayed Action                      | -                  |
| Back Check                          | -                  |
| Opening Angle                       | 110°               |
| Door Width                          | 595-1100mm         |
| BS8300 Min Door Width               | 835mm              |
| Max Door Weight                     | <130kg             |
| Power Adjustment                    | By Spring          |
| Hold Open (not for fire doors)      | o                  |
| Dimensions                          | W243 x H52 x D32mm |
| <b>Certification Compliance</b>     |                    |
| EPD 3.09E+01 kg CO <sub>2</sub> eq  | ✓                  |
| <b>Key:</b> ✓ Yes   - No   o Option |                    |

**Finishes**

See page 96 for more detail



SE  
Silver



SNP  
Satin Nickel

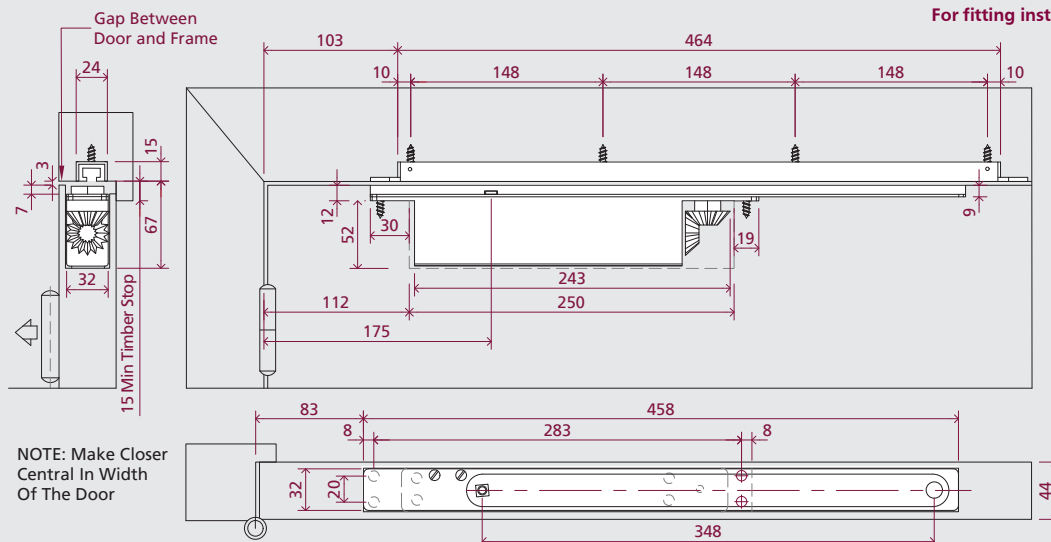



CONCEALED DOOR CLOSERS

# ITS.H3 – Heel Closer

The Rutland concealed Heel Closer requires no cut-out in the floor or frame of the door and can be used in doors of minimum thickness 40mm.

- Available with 'Hold-open' or 'non-hold-open'
- Fixed power size 3
- Adjustable closing and latching speed



Opening Angle  
150°



Two-Stage  
Speed Regulation



Guarantee



Max Door  
Width



Max Door  
Weight



**Finishes**

See page 96 for more detail



SE  
Silver

| Product Features                    | ITS.H3 – Heel Closer |
|-------------------------------------|----------------------|
| Hold Open                           | o                    |
| Opening Angle                       | 150°                 |
| Max Door Width                      | 1000mm               |
| Max Door Weight                     | <100kg               |
| Power Adjustment                    | By Spring            |
| Hold Open (not for fire doors)      | 90°                  |
| Dimensions                          | W181 x H93 x D32mm   |
| <b>Key:</b> ✓ Yes   - No   o Option |                      |

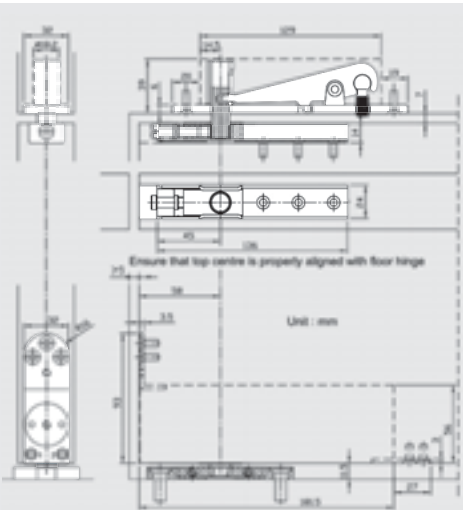

All dimensions shown are in mm.

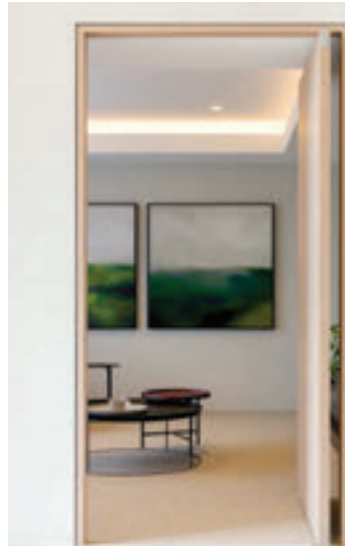



# Electromagnetic Door Closers

Highly adaptable closers, suitable for use in varying applications, from care-homes to airports.

Available in a variety of finishes.



## Responder 24 PAGE 36

- Fixed power size EN 4
- Available as either Hold open or Swing free
- UKCA marked
- Activated by fire alarm or over ridden on the switch if required
- Power supply unit available on request
- Easy to use template fitting instructions



## TS.Firetrak.114 PAGE 38

- Variable power size EN 2-4
- CE marked
- Electromagnet is activated by the fire alarm or over-ridden on the switch



## TS.Firetrak.115 PAGE 39

- Variable power size EN 2-5
- CE marked
- Electromagnet is activated by the fire alarm or over-ridden on the switch

ELECTROMAGNETIC DOOR CLOSERS

# Responder 24

**Power Supply Unit**  
Please see page 55  
for more detail.



ELECTROMAGNETIC DOOR CLOSERS

# Responder 24

Offering Hold-Open & Swing-free modes, and being fully universal fitting with left, right, push & pull available from one box, the Responder 24 is a highly adaptable closer, suitable for use in varying applications, from care-home scenarios where swing-free is in demand, to airports and schools, where high-traffic passes through a door.

- Electromagnetic technology ensuring safe closure in a fire alarm activation
- 5 Finishes available for next day delivery
- Fire tested to EN1634-1 standard



3rd Party Certification



Opening Angle 150°



Two-Stage Speed Regulation



Guarantee



Max Door Width



Max Door Weight



**Finishes**

See page 96 for more detail



SE Silver



SNP Satin Nickel



PNP Polished Nickel



PVD Polished Brass



AB Antique Brass

Rutland PSU is recommended and suitable for 4 E-mag devices.

We recommend the fitter consults with the cable voltage drop table due to the fact that cable sizing and length from PSU to Responder 24 can affect voltage drop.

It is the responsibility of the fitter to ensure the correct cable thickness is used for the situation in hand.



1720

1812

**Product Features**

**Responder 24**

|                              |                    |
|------------------------------|--------------------|
| Delayed Action               | -                  |
| Back Check                   | -                  |
| Opening Angle                | 150°               |
| Fig.1 Pull Side Door Width   | 385-1100mm         |
| Fig.66 Push Side Door Width  | 502-1100mm         |
| Fig 61 Transom Mount         | 385-1100mm         |
| Max Door Weight              | <80kg              |
| Power Adjustment             | -                  |
| Hold Open                    | o                  |
| Dimensions (including cover) | W307 x H67 x D95mm |

**Certification Compliance**

|                                    |   |
|------------------------------------|---|
| Certifire                          | - |
| UKCA                               | ✓ |
| CE                                 | ✓ |
| BS EN 1154                         | ✓ |
| BS EN 1155                         | ✓ |
| BS EN 1634                         | ✓ |
| UL10C                              | - |
| UL228                              | - |
| ANSI BHMA                          | - |
| IFCC                               | ✓ |
| EPD 3.09E+01 kg CO <sub>2</sub> eq | ✓ |

**Key:** ✓ Yes - No o Option

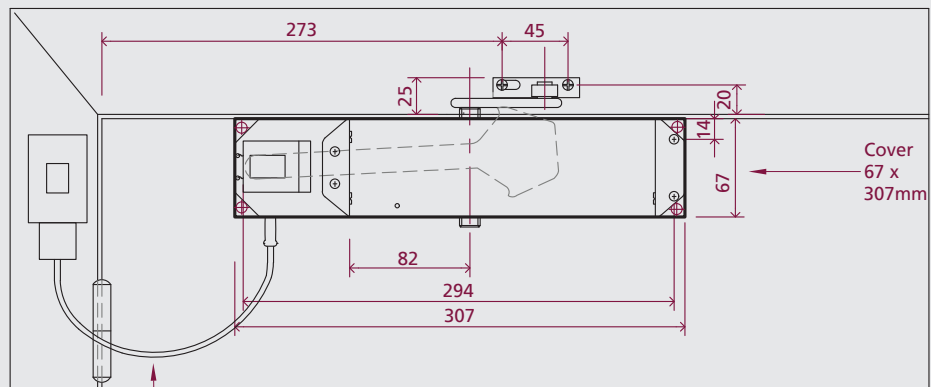
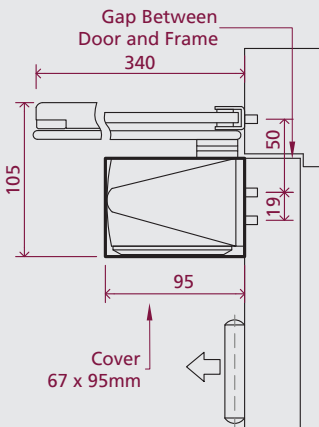

Wire Length 300mm

All dimensions shown are in mm.

For fitting instructions see website

ELECTROMAGNETIC DOOR CLOSERS

# TS.FIRETRAK.114

The TS.FIRETRAK.114 Electromagnetic Slide Arm Closer is a surface mounted Electromagnetic hold open slide arm with cam action door closer designed for fire and smoke compartmentation doors. Fire and smoke doors will operate in a controlled close with the TS.FIRETRAK.114 when the fire or smoke alarm is activated.

- Universal Application
- Power Adjustable by spring, size 2-4
- Available in Silver or Satin Nickel for next day delivery



3rd Party Certification



Opening Angle 130°



Two-Stage Speed Regulation

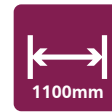

Max Door Width 1100mm



Max Door Weight 80Kg



Guarantee 5 YEARS



Assists BS8300



| Product Features                | TS.FIRETRAK.114    |
|---------------------------------|--------------------|
| Delayed Action                  | -                  |
| Back Check                      | -                  |
| Opening Angle                   | 130°               |
| Door Width                      | 600-1100mm         |
| BS8300 Min Door Width           | 857mm              |
| Max Door Weight                 | <80kg              |
| Power Adjustment                | By Spring          |
| Hold Open                       | ✓                  |
| Dimensions (including cover)    | W253 x H61 x D39mm |
| Certification Compliance        |                    |
| Certifire                       | -                  |
| UKCA                            | -                  |
| CE                              | ✓                  |
| BS EN 1154                      | ✓                  |
| BS EN 1155                      | ✓                  |
| BS EN 1634                      | ✓                  |
| UL10C                           | -                  |
| UL228                           | -                  |
| ANSI BHMA                       | -                  |
| IFCC                            | ✓                  |
| <b>Key:</b> ✓ Yes - No ◦ Option |                    |

Finishes

See page 96 for more detail



SE Silver



SNP Satin Nickel



1812

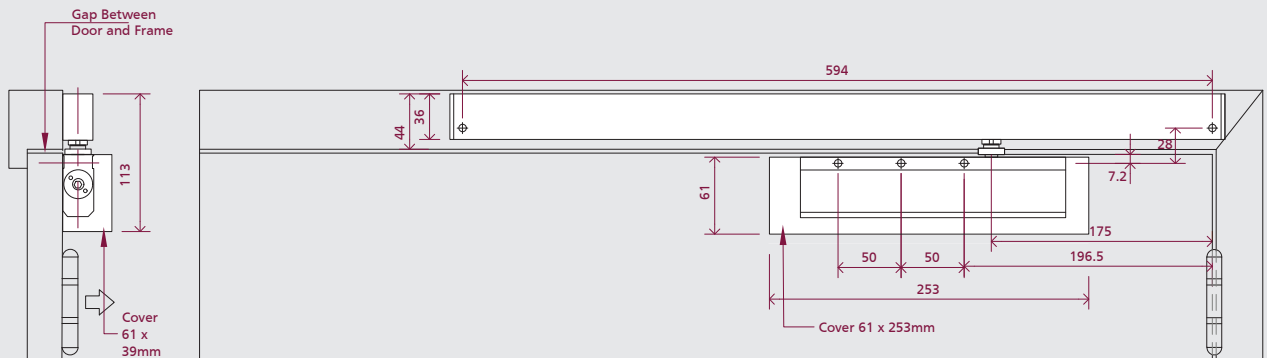

When E-mag door closers are to be interfaced with fire & smoke alarm systems they are to be installed by competent installers in accord with BS 7273-4 code of practice.

For fitting instructions see website

All dimensions shown are in mm.

ELECTROMAGNETIC DOOR CLOSERS

# TS.FIRETRAK.115

The TS.FIRETRAK.115 Electromagnetic Slide Arm Closer is a surface mounted Electromagnetic hold-open slide arm with cam action door closer designed for fire and smoke compartmentation doors. Fire and smoke doors will operate in a controlled close with the TS.FIRETRAK.115 when the fire alarm is activated.

- Universal Application
- Power Adjustable by spring, size 2-5
- Available in Silver or Satin Nickel for next day delivery



3rd Party Certification



Opening Angle 130°



Two-Stage Speed Regulation



Max Door Width 1250mm



Max Door Weight 110Kg



Guarantee 5 YEARS



Assists BS8300



| Product Features                      | TS.FIRETRAK.115    |
|---------------------------------------|--------------------|
| Delayed Action                        | -                  |
| Back Check                            | -                  |
| Opening Angle                         | 130°               |
| Door Width                            | 600-1250mm         |
| BS8300 Min Door Width                 | 857mm              |
| Max Door Weight                       | <110kg             |
| Power Adjustment                      | By Spring          |
| Hold Open                             | ✓                  |
| Dimensions (including cover)          | W254 x H68 x D43mm |
| <b>Certification Compliance</b>       |                    |
| Certifire                             | -                  |
| UKCA                                  | -                  |
| CE                                    | ✓                  |
| BS EN 1154                            | ✓                  |
| BS EN 1155                            | ✓                  |
| BS EN 1634                            | ✓                  |
| UL10C                                 | -                  |
| UL228                                 | -                  |
| ANSI BHMA                             | -                  |
| IFCC                                  | ✓                  |
| <b>Key:</b> ✓ Yes    - No    ◦ Option |                    |

**Finishes** See page 96 for more detail



SE Silver



SNP Satin Nickel



1812

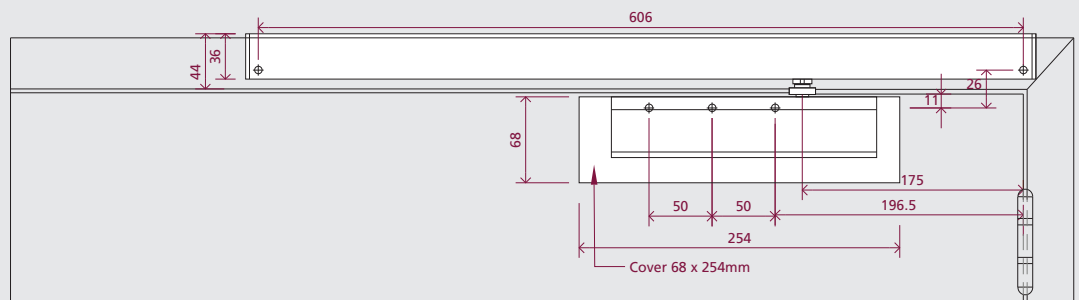
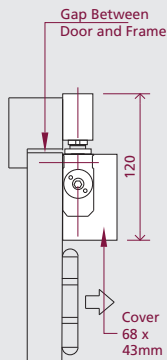

When E-mag door closers are to be interfaced with fire & smoke alarm systems they are to be installed by competent installers in accord with BS 7273-4 code of practice.

For fitting instructions see website

All dimensions shown are in mm.

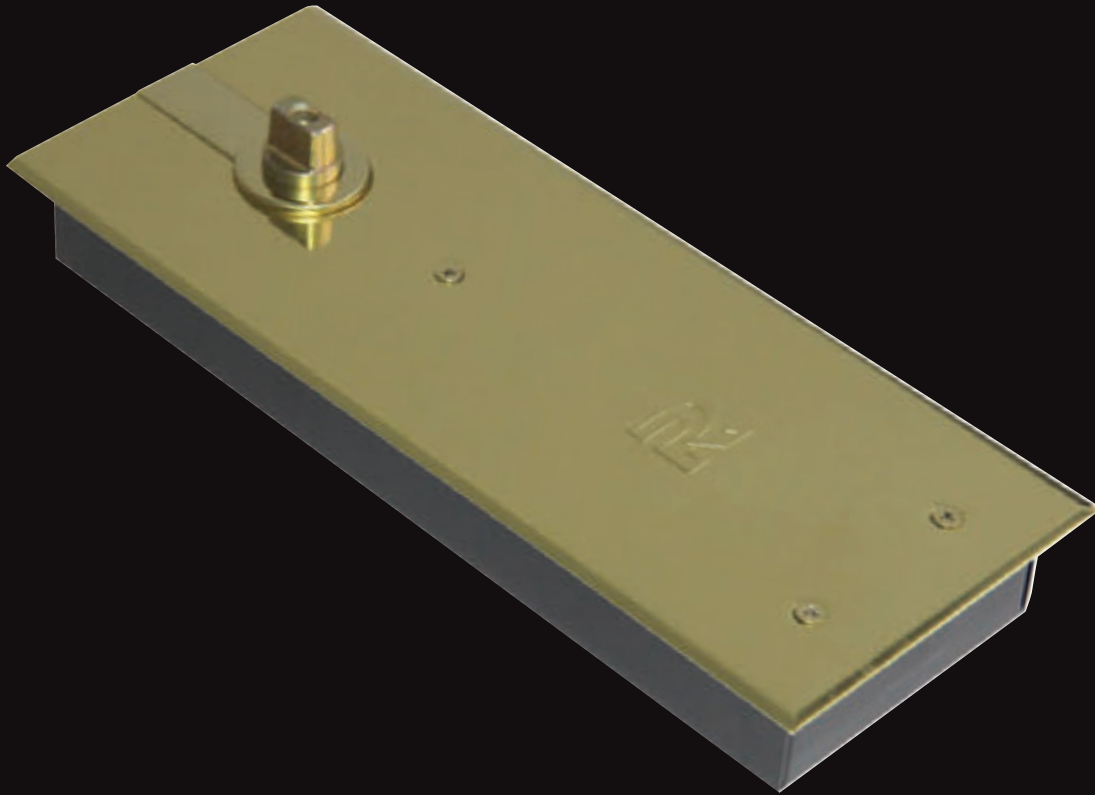

# Floor Spring Door Closers

Ideal for locations such as hospitals  
and care homes where easy opening  
is essential.

Available in a variety of finishes.





### TS.7003 + TS.7004 PAGE 42

- Available in two power sizes – EN 3/4
- UKCA marked and UL listed
- Renown for its Adaptability and Reliability
- Standard spindle size - 8mm



### TS.7104 PAGE 44

- Adjustable power size EN 1-4
- UKCA marked
- Standard spindle size - 8mm



### TS.7306 PAGE 45

- Variable power size EN3-6, adjustable by spring
- Available in double or single action kits
- Standard spindle size - 8mm

FLOOR SPRING DOOR CLOSERS

# TS.7003 + TS.7004



FLOOR SPRING DOOR CLOSERS

# TS.7003 + TS.7004

The Rutland TS.7003 + TS.7004 Floor Spring range is made up of two different power sizes - EN3 and EN4. These closers are ideal for locations such as hospitals and care homes where easy opening is essential. They are enhanced with powerful, user friendly cam and roller action mechanisms.

- Varying spindle options from 3mm-48mm (8mm supplied as standard)
- Available in Satin Stainless finish, special finishes available on request
- Hollow mount cradle available for hollow floor mounting



3rd Party Certification



Opening Angle 130°



Two-Stage Speed Regulation



Guarantee



Max Door Width



Max Door Weight

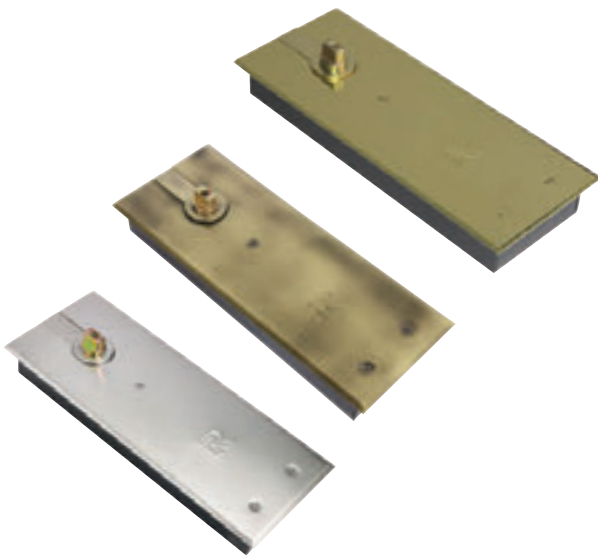

**Finishes**

See page 96 for more detail

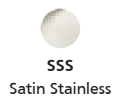

Special finishes available upon request



| Product Features                             | TS.7003 + TS.7004   |
|--|---------------------|
| Delayed Action                               | -                   |
| Back Check (optional not covered by CE/UKCA) | o                   |
| Opening Angle                                | 130°                |
| Max Door Width EN3                           | 950mm               |
| Max Door Width EN4                           | 1150mm              |
| Max Door Weight EN3                          | <105kg              |
| Max Door Weight EN4                          | <150kg              |
| Power Adjustment                             | -                   |
| Hold Open (not for fire doors)               | o                   |
| Dimensions (including cover)                 | W305 x H40 x D106mm |
| Certification Compliance                     |                     |
| Certifire                                    | -                   |
| UKCA   | ✓                   |
| CE   | -                   |
| BS EN 1154                                   | ✓                   |
| BS EN 1634                                   | ✓                   |
| UL10C  | ✓                   |
| UL228  | ✓                   |
| ANSI BHMA                                    | -                   |
| IFCC   | ✓                   |
| <b>Key:</b> ✓ Yes    - No    o Option        |                     |

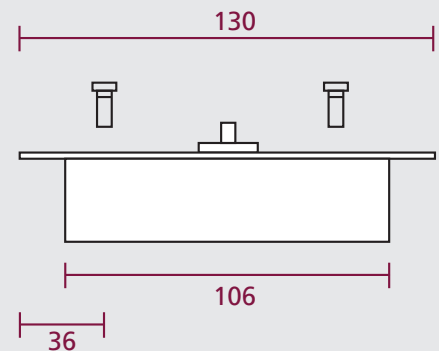
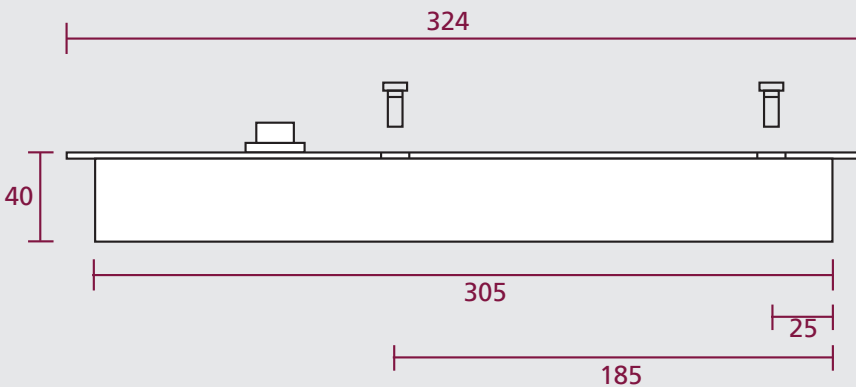

All dimensions shown are in mm.

For fitting instructions see website

FLOOR SPRING DOOR CLOSERS

# TS.7104

The Rutland TS.7104 Floor Spring is a slimline floor spring ideal for locations such as hospitals and care homes where ease of opening is essential. It comes with adjustable power size EN1-4 and is enhanced by a powerful, user friendly cam and roller action mechanism.

- Variable Power size EN1-4 – doors up to 150kg & 1150mm wide
- Available in Satin Stainless finish, special finishes available on request
- Varying spindle options from 3mm-48mm (8mm supplied as standard)



WF 427764



Opening Angle  
130°



Two-Stage  
Speed Regulation



Guarantee



Max Door  
Width



Max Door  
Weight

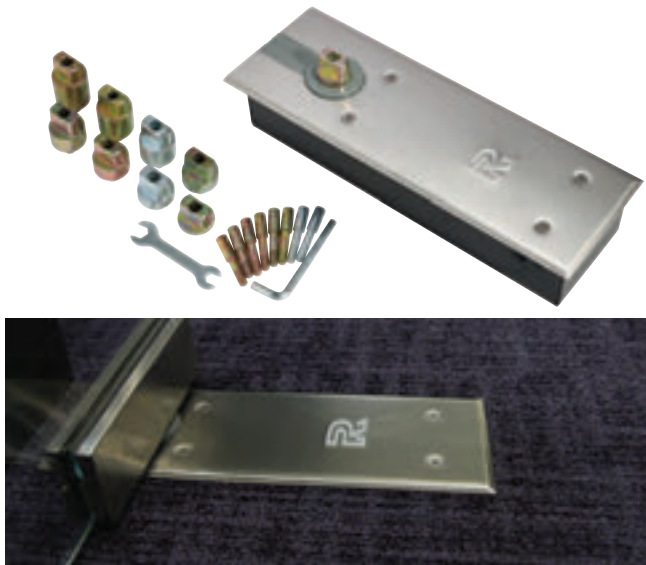

**Product Features**

**TS.7104**

|                              |                    |
|------------------------------|--------------------|
| Delayed Action               | -                  |
| Back Check                   | -                  |
| Opening Angle                | 130°               |
| Max Door Width               | 1150mm             |
| Max Door Weight              | <150kg             |
| Power Adjustment             | By Spring          |
| Hold Open                    | o                  |
| Dimensions (including cover) | W274 x H50 x D81mm |

**Certification Compliance**

|            |   |
|------------|---|
| Certifire  | - |
| UKCA       | ✓ |
| CE         | - |
| BS EN 1154 | ✓ |
| BS EN 1634 | ✓ |
| UL10C      | - |
| UL228      | - |
| ANSI BHMA  | - |
| IFCC       | - |

**Key:** ✓ Yes    - No    o Option

**Finishes**

See page 96 for more detail



Special finishes available upon request

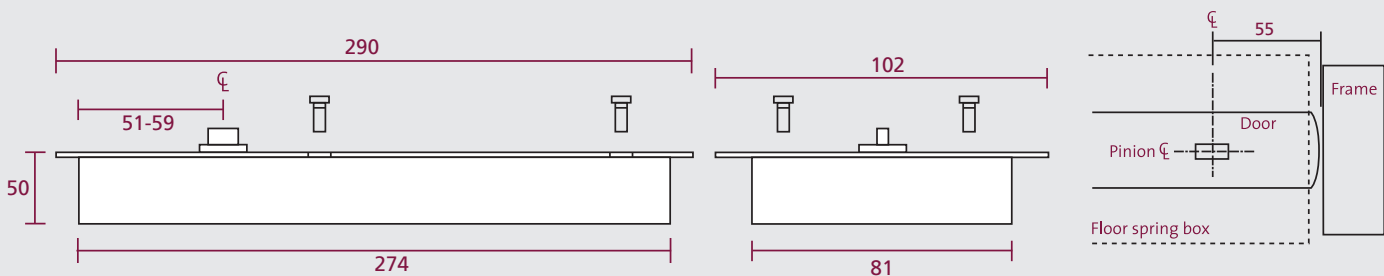

For fitting instructions see website

All dimensions shown are in mm.

FLOOR SPRING DOOR CLOSERS

# TS.7306

The Rutland TS.7306 Heavy Duty Floor Spring has a variable power size EN3-6 adjustable by spring. Available as double or single action units as well as hold open and non-hold open.

- Variable Power size EN3-6 – doors up to 300kg & 1450mm wide
- Power Adjustable by spring, size 3-6
- Varying spindle options from 3mm-48mm (8mm supplied as standard)



Opening Angle  
150°



Two-Stage  
Speed Regulation



Guarantee



Max Door  
Width



Max Door  
Weight



**Finishes**

See page 96 for more detail



| Product Features                      | TS.7306            |
|---------------------------------------|--------------------|
| Delayed Action                        | -                  |
| Back Check                            | -                  |
| Opening Angle                         | 150°               |
| Max Door Width                        | 1450mm             |
| Max Door Weight                       | <300kg             |
| Power Adjustment                      | By Spring          |
| Hold Open                             | o                  |
| Dimensions (including cover)          | W326 x H62 x D96mm |
| <b>Key:</b> ✓ Yes    - No    o Option |                    |

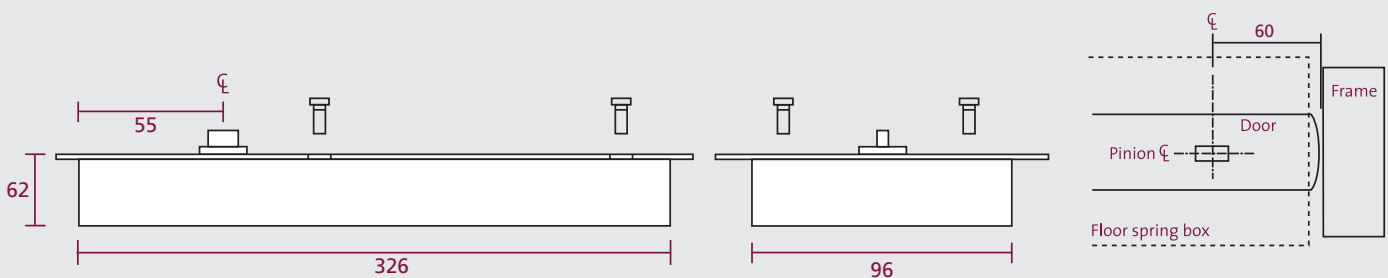

For fitting instructions see website

All dimensions shown are in mm.

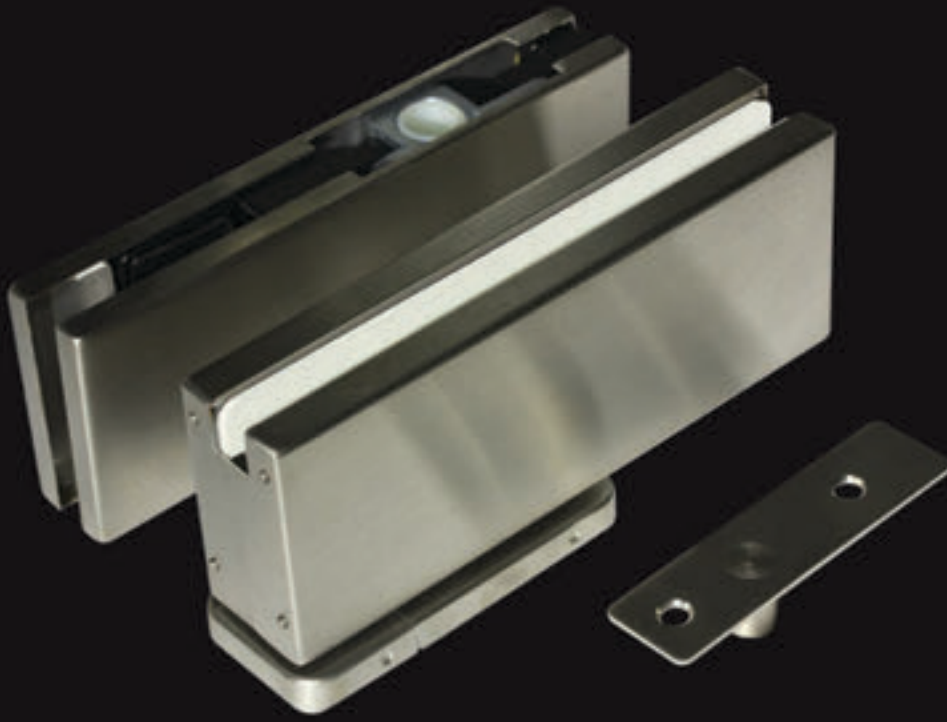

# Glass Patch Closers

Ideal for situations such as concrete floors where it's difficult to use the traditional Floor Spring closers.

For use with glass thicknesses from 8-13mm.



### GP.3 PAGE 48

- Fixed power size EN 3
- UL listed
- Ideal for concrete floors with underfloor services, pipes and mains
- Average saving of 1 hour for fitting compared to traditional floor springs



### GP.35 PAGE 49

- Variable power size EN 3-5
- UL listed
- Ideal for concrete floors with underfloor services, pipes and mains
- Average saving of 1 hour fitting compared to traditional floor springs

GLASS PATCH DOOR CLOSERS

# GP.3

The Rutland GP.3 Hydraulic Glass Patch Closer is a size EN 3 closer and has been used in many varied applications globally, ideal for situations such as concrete floors where it's difficult to use the traditional Floor Spring closer due to underfloor heating and services. Glass thickness can vary from 8mm to 13mm due to the necessary fitting packs, spacers and supports. This is available in a non-hold open mechanism.



Opening Angle  
130°



Two-Stage  
Speed Regulation



Guarantee



Max Door  
Width





Max Door  
Weight

- Universal Application
- Available in Satin Stainless Steel or Black
- Hold-Open or Non-Hold-Open available



**Finishes**

See page 96 for more detail

-  SSS  
Satin Stainless
-  BK  
Black



| Product Features                    | GP.3                 |
|-------------------------------------|----------------------|
| Delayed Action                      | -                    |
| Back Check                          | -                    |
| Opening Angle                       | 130°                 |
| Max Door Width                      | 950mm                |
| Max Door Weight                     | <80kg                |
| Power Adjustment                    | -                    |
| Hold Open                           | o                    |
| Dimensions (including cover)        | W186.5 x H71 x D40mm |
| <b>Key:</b> ✓ Yes   - No   o Option |                      |

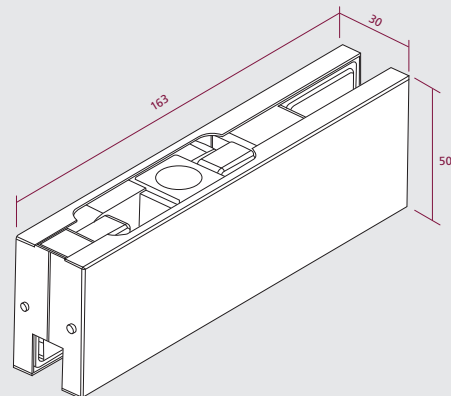
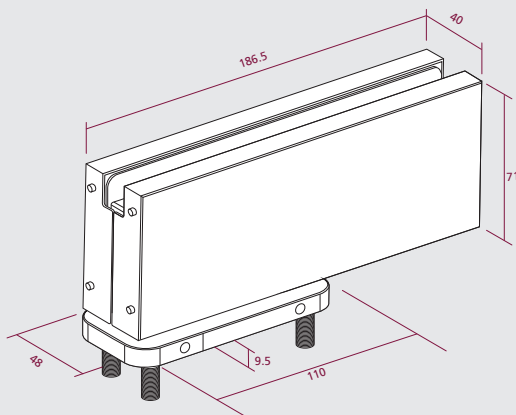

For fitting instructions see website

All dimensions shown are in mm.



GLASS PATCH DOOR CLOSERS

# GP.35

Similar to the GP.3 door closer, the GP.35 Hydraulic Glass Patch Closer is commonly used in situations where floor spring closers are not an option due to underfloor heating and services. The difference with the GP.35 is the power size, in that it is power adjustable size EN3-5. Glass thickness can vary from 10-15mm, and a non-hold open mechanism is available.

- Power adjustable size EN3-5
- Universal application
- Available in Satin Stainless finish



Opening Angle  
130°



Two-Stage  
Speed Regulation



Guarantee



Max Door  
Width



Max Door  
Weight



**Finishes**

See page 96 for more detail



| Product Features                    | GP.35                |
|-------------------------------------|----------------------|
| Delayed Action                      | -                    |
| Back Check                          | -                    |
| Opening Angle                       | 130°                 |
| Max Door Width                      | 1250mm               |
| Max Door Weight                     | <100kg               |
| Power Adjustment                    | By Spring            |
| Hold Open                           | o                    |
| Dimensions (including cover)        | W186.5 x H71 x D40mm |
| <b>Key:</b> ✓ Yes   - No   o Option |                      |

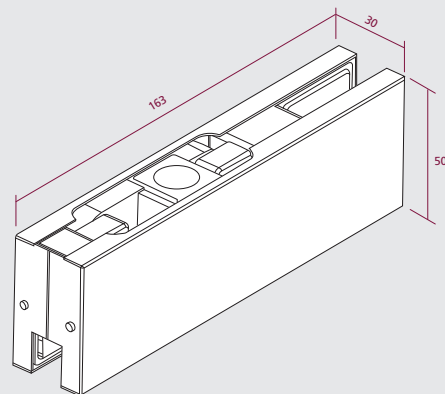
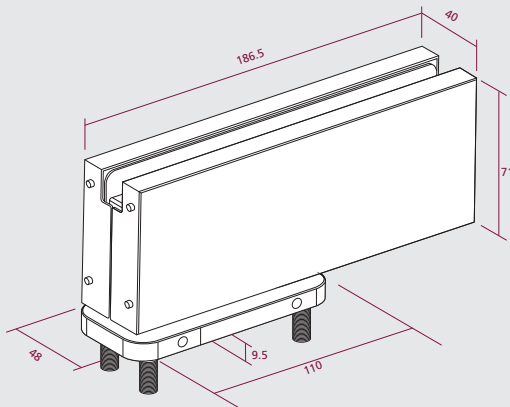

For fitting instructions see website

All dimensions shown are in mm.

TRANSOM CLOSERS

# TS.8000

Designed for egress doors not needing to be fire rated, the Rutland TS.8000 Transom Closers are fitted into the transom of a door which is the top of the door frame, and feature cam and roller mechanisms. They are supplied in three fixed power sizes as standard - EN2, EN3 + EN4.

- Available as Hold-Open or Non-Hold Open
- Easy opening with cam and roller mechanism
- Universal application



Opening Angle  
130°



Two-Stage  
Speed Regulation



Guarantee

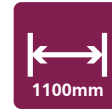

Max Door  
Width



Max Door  
Weight

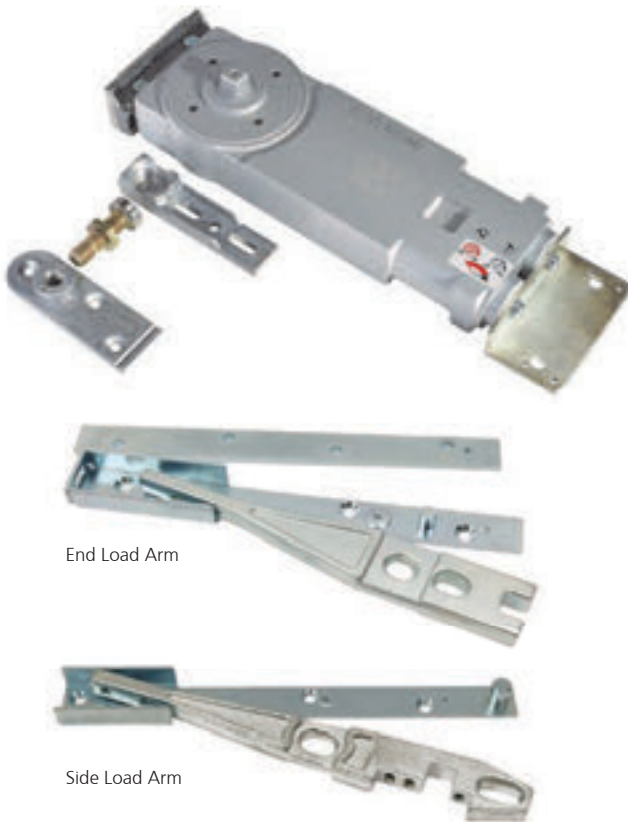

End Load Arm

Side Load Arm

| Product Features                      | TS.8000   |
|---------------------------------------|---|
| Delayed Action                        | -   |
| Back Check                            | -   |
| Opening Angle                         | 130°  |
| Max Door Width                        | TS.8002 - 850mm<br>TS.8003 - 950mm<br>TS.8004 - 1100mm            |
| Max Door Weight                       | TS.8002 - <70kg<br>TS.8003 - <105kg<br>TS.8004 - <150kg           |
| Max Door Weight                       | TS.8002 - Fixed EN2<br>TS.8003 - Fixed EN3<br>TS.8004 - Fixed EN4 |
| Hold Open                             | o   |
| Dimensions (including cover)          | W270 x H38 x D91mm  |
| <b>Key:</b> ✓ Yes    - No    o Option |   |

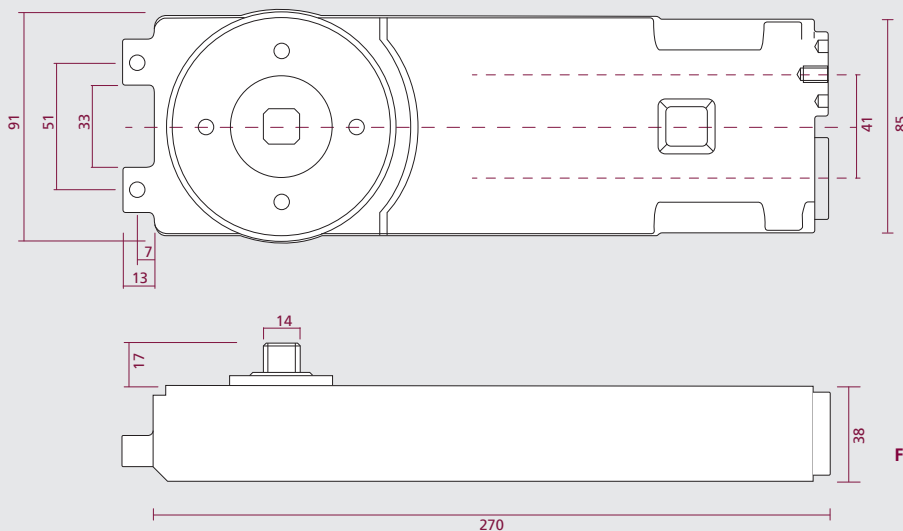

For fitting instructions see website

All dimensions shown are in mm.

ACCESSORIES – DOOR RESTRICTOR

# DR.11000

The DR.11000 Door Restrictor is an ideal option for external doors such as loading bays or goods store entrances to stop the door from getting damaged by the masonry or being ripped off its hinges in windy locations. It comes with the option of a hold open clip which can be inserted to hold the door open, and a cushion stop which acts similar to back check and saves damage to the building and door. The DR.11000 is available in heavy duty silver finish.

- Fully concealed when the door is closed
- Available with Hold-open or cushion stop
- Acts as a restrictor on the door in windy locations



**Finishes**

See page 96 for more detail

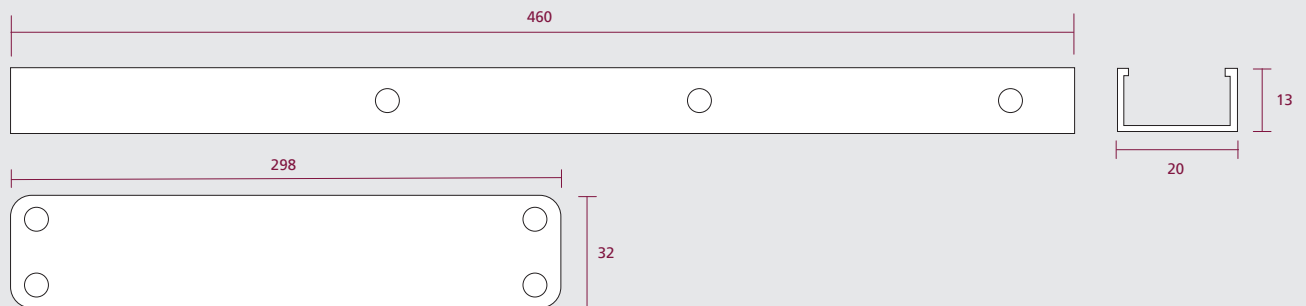
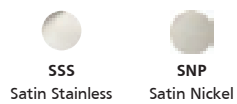

For fitting instructions see website

All dimensions shown are in mm.

## ACCESSORIES – BRACKETS

# Brackets

Every door closer at some point needs a slightly different bracket to help with the fitting or application on hand. At Rutland this is recognized, considered, designed, manufactured and therefore brackets are stocked to assist with the different door closer fittings and applications.

**There may be an alternative bracket required for your situation and the staff at Rutland will be willing to assist with your requirements.**



## Bracket Options:

- Extended Parallel Arm Bracket – available in a wide range of finishes to suit
- Extra Long Parallel Arm Bracket – available in a wide range of finishes to suit
- Glass door shoe to suit glass (10mm thickness) – for pull side fitting - available in Silver finish
- Soffit Mounting bracket – available in Silver finish
- Pinion Bracket – available in Silver finish
- 'Z' Bracket – available in Silver finish
- Angled 'Z' Bracket – available in Silver finish
- Slide Rail Drop Plate – available in Silver finish

## ACCESSORIES – POWER SUPPLY UNIT FOR ELECTROMAGNETIC DOOR CLOSERS

# PSU.1224.9

This product is a four way regulated Power supply unit to connect electromagnetic door closers to the fire alarm. The control module offers the options to switch in a fail-safe or fail-secure manner using either volt-free or a 24VDC trigger.

CAVEAT - Rutland PSU is recommended to be suitable for 4 E-mag devices (Responder 24 and FireTrak), however it is recommended that the fitter consults with the cable voltage drop table due to the fact that cable sizing and length can affect voltage drop. It is the responsibility of the fitter to ensure the correct cable thickness is used for the situation in hand.

- Mild steel construction
- White powder coated
- Switch-mode technology
- Four way regulated power supply
- Cable retention points
- LED indicators for O/P, fault & mains
- Output can be fail-safe or fail-secure
- Full electronic protection
- Short circuit protection
- 24VDC regulated output
- Fused output
- Full current to load
- End-of-Life: This product can be returned to Rutland for WEEE regulations
- One PSU can take up to 4 Responders or Firetraks (see caveat above)



### Technical Information

### PSU.1224

|            |                                   |
|------------|-----------------------------------|
| Output     | 24VDC                             |
| Max Amp    | 4A                                |
| Max Load   | Up to 4/5 Responders or Firetraks |
| Dimensions | W200 x H200 x D65mm               |

When E-mag door closers are to be interfaced with fire & smoke alarm systems they are to be installed by competent installers in accord with BS 7273-4 code of practice.

PIVOT SETS

# PS.100

Including a retractable top centre pivot with cover plate and bottom strap, the Rutland PS.100 Double Action Pivot set uniquely fits to the frame leg and head which takes away the need to have any fixings into the floor, making it quicker to fit and more adaptable.

- Max Door Weight 80kg
- Double Action
- Grade 314 stainless steel
- Retractable top pivot

\*Intumescent must be used on fire doors



Max Door Weight



Finishes

See page 96 for more detail



SSS  
Satin Stainless

PIVOT SETS

# PS.170

For single action use, the Rutland PS.170 pivot set has a retractable top centre pivot with a cover plate and bottom strap.

- Max Door Weight 80kg
- Single Action
- Medium duty pivot to suit TS.7000 floor springs
- Tested for use with the spindle bearing PS.260

\*Intumescent must be used on fire doors (IP.70)



Max Door Weight



Finishes

See page 96 for more detail



SSS  
Satin Stainless



PVD  
Polished Brass

## PIVOT SETS

# PS.190

For use on large and heavy door sets, the Rutland PS.190 Heavy Duty Pivot Set has a spindle bearing which helps improve performance and has a double lockable anti-vibration door strap, which helps to hold the door in line and maintains the fire integrity of a door.

- Max Door Weight 175kg
- Spindle bearing for improved performance
- Tested for use with PS.260 floor mounted spindle bearing.

\*Intumescent must be used on fire doors (IP.190)



Max Door Weight



### Finishes

See page 96 for more detail



SSS  
Satin Stainless

## PIVOT SETS

# PS.190100

A medium duty double action pivot set, the Rutland PS.190100 consists of an adjustable top strap and a bottom pivot which is frame fixed, meaning no interference with underfloor heating or services.

- Max Door Weight 80kg
- Double Action
- Spindle bearing for improved performance
- Top pivot with retractable pin for ease of fitting
- Adjustable top stop allowing doors to be aligned/adjusted.

\*Intumescent must be used on fire doors



Max Door Weight



### Finishes

See page 96 for more detail



SSS  
Satin Stainless



PVD  
Polished Brass

ACCESSORIES – PIVOT SETS

# PS.260 Floor Mount Spindle

Rutland’s PS.260 Floor mount spindle is a heavy-duty floor mounted bottom spindle that allows doors to swing both ways, and is compatible with the following components:



Guarantee



Max Door Weight

- PS.170 (Single action pivot)
- PS.190 (Heavy duty double action pivot set)
- TH.106/7 (Emergency release stops)



- Suitable for FD30 and FD60 doors, to BS 476 for both single and double door applications
- 25 year guarantee
- 304 grade stainless steel plate
- Satin Finish
- Bronze bearings oil impregnated for low maintenance

| Product Features                             | PS.260               |
|--|----------------------|
| Min Door Thickness                           | 44mm                 |
| Back Check                                   | -                    |
| Opening Angle                                | 130°                 |
| Max Door Width                               | 1100mm               |
| Max Door Weight                              | <200kg               |
| Permitted door gaps on 44mm thick fire doors | 3mm Gap              |
| Permitted door gaps on 54mm thick fire doors | 3.5mm Gap            |
| Dimensions (including cover)                 | W186.5 x H71 x D40mm |
| <b>Key:</b> ✓ Yes    - No    ◦ Option        |                      |

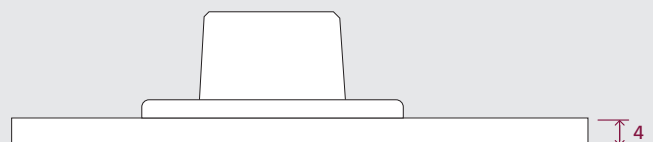
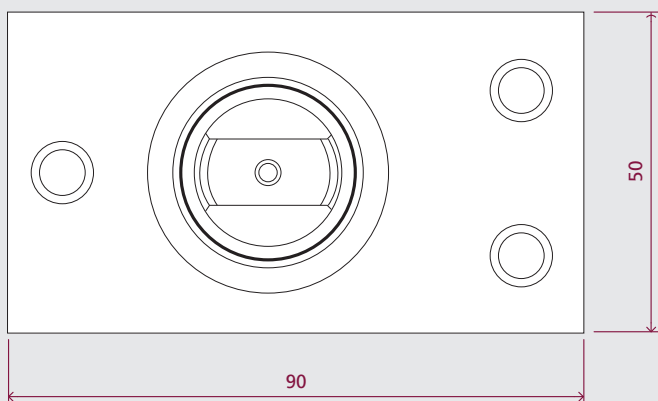



## ACCESSORIES – EMERGENCY RELEASE STOPS

# TH.106/107

TH.106/107 Emergency Release Stop allows for double swing emergency access. In normal circumstances, it stops the door in the closed position. When in an emergency the Stop can be released by using a pen to press in on the centre point on the stop. This is usually fitted to the frame of the door.

## TH.106 Overview:

- 25 Year guarantee
- 304 Grade stainless steel plate
- Satin Finish
- Bronze bearings oil impregnated for low maintenance

## TH.107 Overview:

- Suitable for door thickness 44mm and above
- Heavy duty for internal doors weighing up to 200kg
- Maximum door width 1100mm
- Permitted door gaps on 44mm thick fire doors – 3mm gap is permitted
- Permitted door gaps on 54mm thick fire doors – 3.5mm gap is permitted

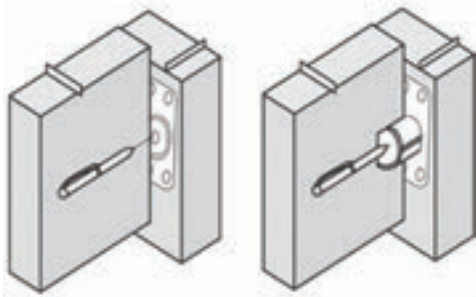

### Finishes

See page 96 for more detail



SSS  
Satin Stainless

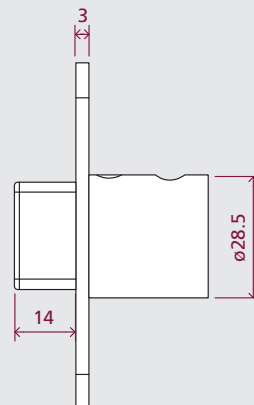
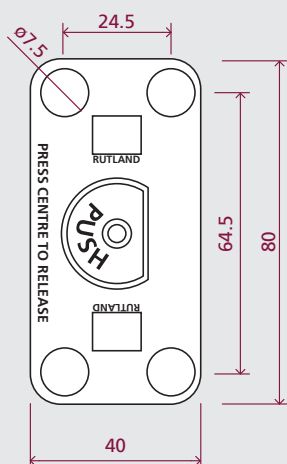

For fitting instructions see website

All dimensions shown are in mm.

# Hold Open Arms

Rutland's Hold-Open arms are designed for use on non-fire rated doors where there is a requirement for the door to be held open. An example of where a hold-open arm might be used is with a standard scissor arm door closer on an exit door.

To coincide with the different fitting positions of a door closer, such as pull side and push side, there are various different hold-open arms available from stock to meet your requirements.

Hold-open arms are available in a range of different finishes, to match your requirements. Please contact Rutland with your requirements for hold-open arms.

**Hold-Open arms are NOT for use on Fire Doors.**

**HOA.2**  
For size 2-6 door closers



**HOPA**  
For push side application size  
2-4 door closers



# Fire Door Hardware

Coming soon: [www.rutlanduk.co.uk/frontiercollection](http://www.rutlanduk.co.uk/frontiercollection)

FIRE & SECURITY DOOR HARDWARE

# Din Locks – Deadlock

- BS EN 12209
- 55mm Backset
- Universal Fitting
- Double Throw Deadbolt
- Adjustable Keep
- Includes Plastic Back Box



3rd Party Certification



Guarantee



Max Door Weight



**Technical Information**

**BS EN 12209 Classification**

Rutland locks have been independently tested to EN 12209 performance standard. They are CE marked and classified.

**Primary Fire Testing**

Rutland locks have been tested to EN 1634 and BS 476. Test certificates are available on request.

**Fire Doors**

Intumescent MUST be used on fire doors – please enquire for latest testing details.

**Finishes**

See page 96 for more detail



SS  
Satin Stainless



**Styles**

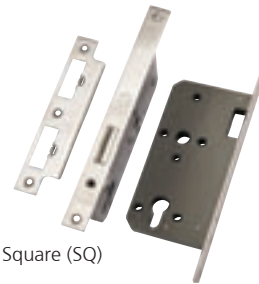

Square (SQ)



Radius (R)

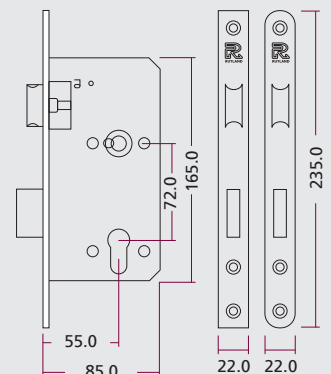
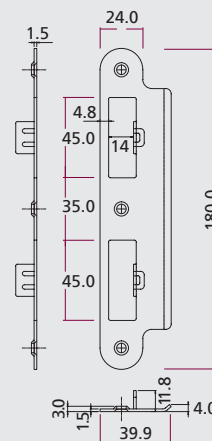
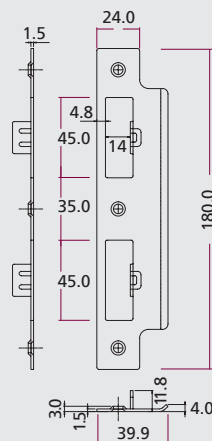
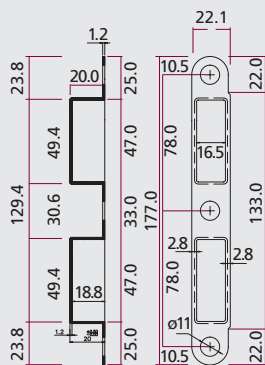

ENHANCING LIFE SAFETY AT EVERY FIRE DOOR

FIRE & SECURITY DOOR HARDWARE

# Din Locks – Euro Sash Lock

- BS EN 12209
- 55mm Backset
- Universal Fitting
- Double Throw Deadbolt
- Adjustable Keep
- Includes Plastic Back Box



3rd Party Certification



Guarantee



Max Door Weight



**Technical Information**

**BS EN 12209 Classification**

Rutland locks have been independently tested to EN 12209 performance standard. They are CE marked and classified.

**Primary Fire Testing**

Rutland locks have been tested to EN 1634 and BS 476. Test certificates are available on request.

**Fire Doors**

Intumescent MUST be used on fire doors – please enquire for latest testing details.

**Finishes**

See page 96 for more detail



SS  
Satin Stainless



**Styles**



Square (SQ)

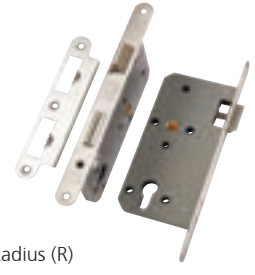

Radius (R)

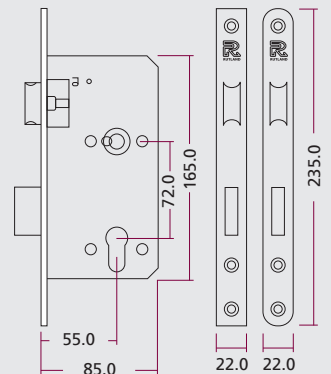
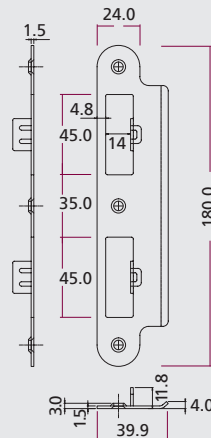
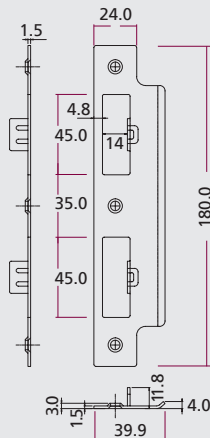
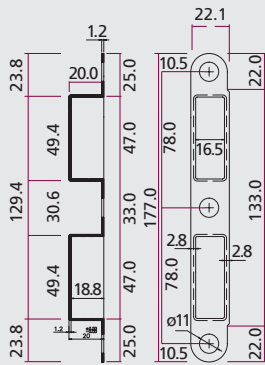

FIRE & SECURITY DOOR HARDWARE

# Din Locks – Bathroom Lock

- BS EN 12209
- 55mm Backset
- Universal Fitting
- Double Throw Deadbolt
- Adjustable Keep
- Includes Plastic Back Box



3rd Party Certification



Guarantee



Max Door Weight



**Technical Information**

**BS EN 12209 Classification**

Rutland locks have been independently tested to EN 12209 performance standard. They are CE marked and classified.

**Primary Fire Testing**

Rutland locks have been tested to EN 1634 and BS 476. Test certificates are available on request.

**Fire Doors**

Intumescent MUST be used on fire doors – please enquire for latest testing details.

**Finishes**

See page 96 for more detail



SS  
Satin Stainless



**Styles**



Square (SQ)



Radius (R)

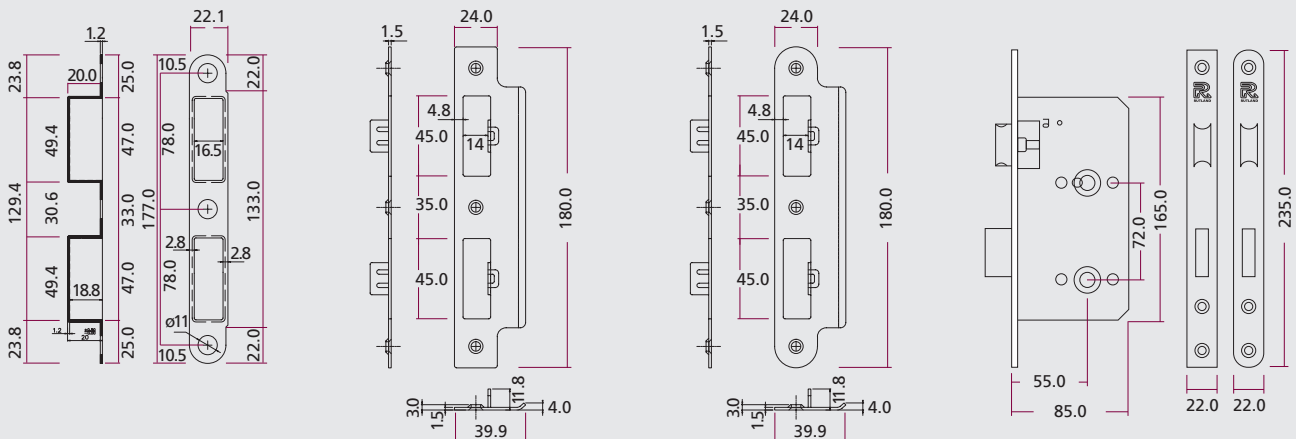

FIRE & SECURITY DOOR HARDWARE

# Din Locks – Latch

- BS EN 12209
- 55mm Backset
- Universal Fitting
- Adjustable Keep
- Includes Plastic Back Box



3rd Party Certification



Guarantee



Max Door Weight



**Technical Information**

**BS EN 12209 Classification**

Rutland locks have been independently tested to EN 12209 performance standard. They are CE marked and classified.

**Primary Fire Testing**

Rutland locks have been tested to EN 1634 and BS 476. Test certificates are available on request.

**Fire Doors**

Intumescent **MUST** be used on fire doors – please enquire for latest testing details.

**Finishes**

See page 96 for more detail



SS  
Satin Stainless



**Styles**

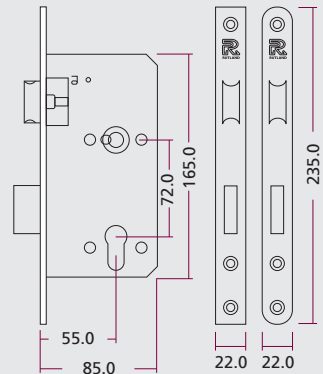
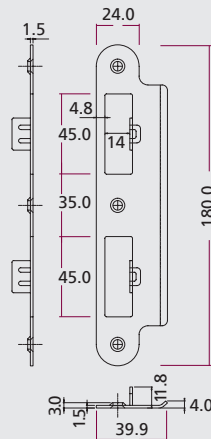
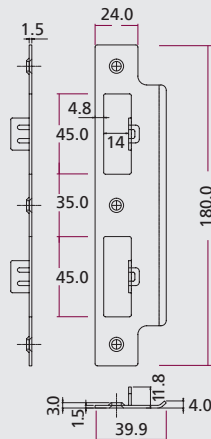
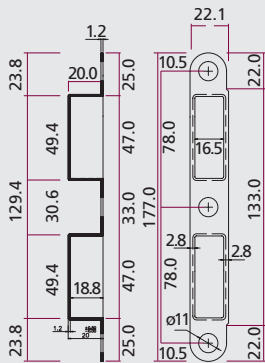
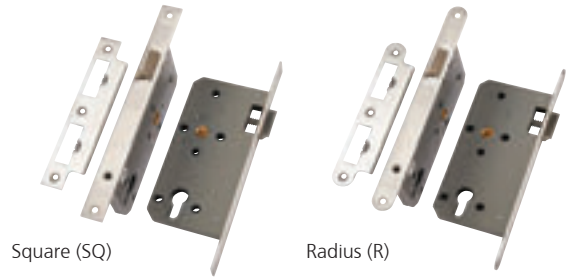

FIRE & SECURITY DOOR HARDWARE

# Handles

## Return to Door Lever Handle

- Complies with BS8300 (formally known as DDA)
- Bolt through fixings included
- Grade 201 Stainless Steel
- Sprung Rose
- Use on door width 35-54mm



Guarantee

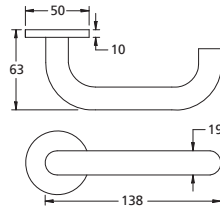

## T-Bar Lever Handle

- Bolt through fixings included
- Grade 201 Stainless Steel
- Sprung Rose
- Use on door width 35-54mm



Guarantee

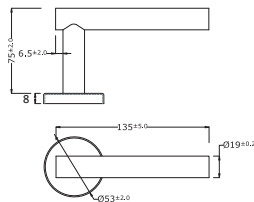

## Mitred Lever Handle

- Bolt through fixings included
- Grade 201 Stainless Steel
- Sprung Rose
- Use on door width 35-54mm



Guarantee

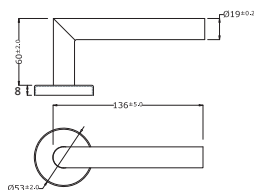



ENHANCING LIFE SAFETY AT EVERY FIRE DOOR

FIRE & SECURITY DOOR HARDWARE

# Hinges - Dog Bolt

- Suitable for use with back check door closers
- Welded button tip
- BS EN 1935 : 2002 Grade 13
- Grade 201 Stainless Steel
- 102 x 76 x 3mm

**15**  
YEARS

Guarantee

**120Kg**

Max Door Weight

**Technical Information**

**BS EN 1935 Classification**

Rutland hinges have been independently tested to EN 1935 performance standard. They are CE marked and classified.

**Primary Fire Testing**

Rutland hinges have been tested to EN 1634 and BS 476. Test certificates are available on request.

**Fire Doors**

Intumescent MUST be used on fire doors – please enquire for latest testing details.

**Finishes**

See page 96 for more detail



SS  
Satin Stainless



**Styles**









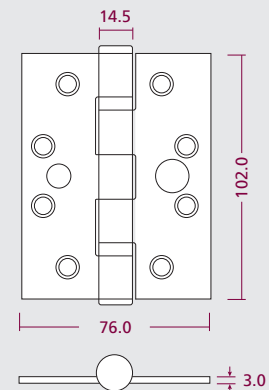

Square (SQ)









Radius (R)



| Description  | EN Size | Finish          | Re-order Code | Product Code          | Box Qty |
|--|---------|-----------------|---------------|-----------------------|---------|
| <b>TS.3204</b>   |         |                 |               |                       |         |
|  TS.3204 Standard unit (closer, snap fix armset and PA bracket)                           | 3/4     | Silver          | <b>11364</b>  | TS.3204.FB.SE         | 10      |
|  TS3204 Combined unit (closer, flat bar armset, cover and PA bracket)                     | 3/4     | Silver          | <b>11371</b>  | TS.3204.SLFB.SESE     | 8       |
|  | 3/4     | Satin Nickel    | <b>11374</b>  | TS.3204.SLFB.SNPSNP   | 8       |
|  | 3/4     | Polished Nickel | <b>11367</b>  | TS.3204.SLFB.PNPPNP   | 8       |
|  | 3/4     | Polished Brass  | <b>11369</b>  | TS.3204.SLFB.PVDPVD   | 8       |
|  | 3/4     | Satin Brass     | <b>11953</b>  | TS.3204.SLFB.SBSB     | 8       |
|  | 3/4     | White           | <b>11329</b>  | TS.3204.SLFB.WHWH     | 8       |
|  | 3/4     | Colour Coated   | <b>11864</b>  | TS.3204.SLFB.RAL*RAL* | 8       |
| <b>WITH BACK CHECK</b>   |         |                 |               |                       |         |
|  TS.3204 Standard unit closer, flat bar armset, cover, PA bracket with <b>BACK CHECK</b>  | 3/4     | Silver          | <b>11394</b>  | TS.3204BC.FB.SE       | 10      |
|  TS.3204 Combined unit closer, flat bar armset, cover, PA bracket with <b>BACK CHECK</b> | 3/4     | Silver          | <b>11397</b>  | TS.3204BC.SLFB.SESE   | 8       |
|  | 3/4     | Satin Nickel    | <b>11399</b>  | TS.3204BC.SLFB.SNPSNP | 8       |
|  | 3/4     | Polished Nickel | <b>11395</b>  | TS.3204BC.SLFB.PNPPNP | 8       |
|  | 3/4     | Polished Brass  | <b>11396</b>  | TS.3204BC.SLFB.PVDPVD | 8       |
|  | 3/4     | Satin Brass     | <b>11954</b>  | TS.3204BC.SLFB.SBSB   | 8       |
| Hollow Door Fixing Packs   |         | Silver          | <b>11149</b>  | HDF.34.SE             | 10      |
|  |         | Satin Nickel    | <b>11150</b>  | HDF.34.SNP            | 10      |
|  |         | Polished Nickel | <b>11147</b>  | HDF.34.PNP            | 10      |
|  |         | Gold            | <b>11146</b>  | HDF.34.GE             | 10      |
|  |         | Polished Brass  | <b>11148</b>  | HDF.34.PVD            | 10      |
|  TS.3204 Covers   |         | Solid Stainless | <b>11293</b>  | SR.34.SSS             | 25      |
|  |         | Silver          | <b>11262</b>  | SL.34.SE              | 25      |
|  |         | Satin Nickel    | <b>11263</b>  | SL.34.SNP             | 25      |
|  |         | Polished Nickel | <b>11260</b>  | SL.34.PNP             | 25      |
|  |         | Polished Brass  | <b>11261</b>  | SL.34.PVD             | 25      |
|  |         | Satin Brass     | <b>11432</b>  | SL.34.SB              | 25      |
|  TS.3204 Body only with <b>BACK CHECK</b>   | -       | Silver          | <b>11414</b>  | TS.3204BCSE           | 25      |
| TS.3204 Body only  | -       | Silver          | <b>11412</b>  | TS.3204SE             | 25      |
|  Drop plate (includes fixings)  | -       | Silver          | <b>11039</b>  | DP.34.SE              | 10      |
| Fixing pack  | -       | Silver          | <b>11961</b>  | FIX.34.SE             | 10      |



| Description   | EN Size | Finish   | Re-order Code | Product Code            | Box Qty |
|---|---------|--|---------------|-------------------------|---------|
| <b>TS.4204</b>  |         |  |               |                         |         |
|  | 2-4     | Silver        | <b>12495</b>  | TS.4204DABC.SRFB.SESE   | 8       |
|   | 2-4     | Satin Nickel  | <b>12496</b>  | TS.4204DABC.SRFB.SNPSNP | 8       |

**TS.5204****WITH DELAYED ACTION AND BACK CHECK**

|   |     |   |              |                           |    |
|---|-----|---|--------------|---------------------------|----|
|    | 2-4 | Silver           | <b>11501</b> | TS.5204DABC.FB.SE         | 10 |
|   | 2-4 | Silver           | <b>11826</b> | TS.5204DABC.SRFB.SESE     | 8  |
|    | 2-4 | Satin Nickel     | <b>11272</b> | TS.5204DABC.SRFB.SNPSNP   | 8  |
|   | 2-4 | Polished Nickel  | <b>11273</b> | TS.5204DABC.SRFB.PNPPNP   | 8  |
|   | 2-4 | Polished Brass   | <b>11274</b> | TS.5204DABC.SRFB.PVDPVD   | 8  |
|   | 2-4 | Black            | <b>12526</b> | TS.5204DABC.SRFB.RAL9011  | 8  |
|   | 2-4 | Colour Coated   | <b>11253</b> | TS.5204DABC.SRFB.RAL*RAL* | 8  |
|  | 2-4 | Silver         | <b>11822</b> | TS.5204DABC               | 10 |

**WITH BACK CHECK**



|   |     |   |              |                         |    |
|---|-----|---|--------------|-------------------------|----|
|  | 2-4 | Silver           | <b>11406</b> | TS.5204BC.FB.SE         | 10 |
|   | 2-4 | Silver           | <b>11409</b> | TS.5204BC.SRFB.SESE     | 6  |
|  | 2-4 | Satin Nickel     | <b>11410</b> | TS.5204BC.SRFB.SNPSNP   | 6  |
|   | 2-4 | Polished Nickel  | <b>11407</b> | TS.5204BC.SRFB.PNPPNP   | 6  |
|   | 2-4 | Polished Brass   | <b>11408</b> | TS.5204BC.SRFB.PVDPVD   | 6  |
|   | 2-4 | Black            | <b>12525</b> | TS.5204BC.SRFB.RAL9011  | 6  |
|   | 2-4 | Colour Coated   | <b>11867</b> | TS.5204BC.SRFB.RAL*RAL* | 6  |
|  | 2-4 | Silver           | <b>11415</b> | TS.5204BC.SE            | 10 |
|   |     | Silver           | <b>11296</b> | SR.54.SE                | 25 |
|  |     | Satin Nickel     | <b>11297</b> | SR.54.SNP               | 25 |
|   |     | Polished Nickel  | <b>11294</b> | SR.54.PNP               | 25 |
|   |     | Polished Brass   | <b>11295</b> | SR.54.PVD               | 25 |
|   |     | Black            | <b>12018</b> | SR.54.RAL9011           | 25 |



| Description   | EN Size | Finish                | Re-order Code | Product Code           | Box Qty |
|---|---------|-----------------------|---------------|------------------------|---------|
| <b>TS.9205</b>  |         |                       |               |                        |         |
|  TS.9205 Slimline architectural door closer standard unit with screw type or flat bar armset, trimplate body, cap and PA bracket. NO COVER | 2-5     | Silver                | <b>11598</b>  | TS.9205.FB.SE          | 10      |
|  TS.9205 Slimline architectural door closer combined unit with flat bar armset, semi-radius cover and PA bracket.                          | 2-5     | Silver                | <b>11626</b>  | TS.9205.SRFB.SESE      | 8       |
|   | 2-5     | Satin Nickel          | <b>11629</b>  | TS.9205.SRFB.SNPSNP    | 8       |
|   | 2-5     | Polished Nickel       | <b>11617</b>  | TS.9205.SRFB.PNPPNP    | 8       |
|   | 2-5     | Polished Brass        | <b>11622</b>  | TS.9205.SRFB.PVDPVD    | 8       |
|   | 2-5     | Satin Stainless Steel | <b>11632</b>  | TS.9205.SRFB.SSSSSS    | 8       |
|   | 2-5     | Polished Stainless    | <b>11620</b>  | TS.9205.SRFB.PSSPSS    | 8       |
|   | 2-5     | Black                 | <b>11884</b>  | TS.9205.SRFB.RAL9011BK | 8       |
|   | 2-5     | Colour Coated         | <b>11883</b>  | TS.9205.SRFB.RALRAL    | 8       |



**WITH BACK CHECK**

|   |     |                       |              |                          |    |
|---|-----|-----------------------|--------------|--------------------------|----|
|  TS.9205BC Slimline architectural door closer standard unit with back check, screw type or flat bar armset, trimplate body, cap and PA bracket. NO COVER | 2-5 | Silver                | <b>11664</b> | TS.9205BC.FB.SE          | 10 |
|  TS.9205BC Slimline architectural door closer combined unit with back check, flat bar armset, semi-radius cover and PA bracket.                         | 2-5 | Silver                | <b>11692</b> | TS.9205BC.SRFB.SESE      | 8  |
|   | 2-5 | Satin Nickel          | <b>11695</b> | TS.9205BC.SRFB.SNPSNP    | 8  |
|   | 2-5 | Polished Nickel       | <b>11683</b> | TS.9205BC.SRFB.PNPPNP    | 8  |
|   | 2-5 | Polished Brass        | <b>11688</b> | TS.9205BC.SRFB.PVDPVD    | 8  |
|   | 2-5 | Satin Stainless Steel | <b>11698</b> | TS.9205BC.SRFB.SSSSSS    | 8  |
|   | 2-5 | Polished Stainless    | <b>11686</b> | TS.9205BC.SRFB.PSSPSS    | 8  |
|   | 2-5 | Black                 | <b>11773</b> | TS.9205BC.SRFB.RAL9011BK | 8  |
|   | 2-5 | Colour Coated         | <b>11912</b> | TS.9205BC.SRFB.RAL*RAL*  | 8  |

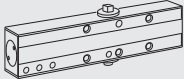
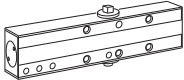
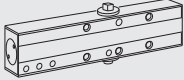
**WITH DELAYED ACTION AND BACK CHECK**

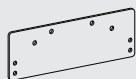
|   |     |                       |              |                              |    |
|---|-----|-----------------------|--------------|------------------------------|----|
|  TS.9205DABC Slimline architectural door closer standard unit with back check, delayed action, screw type or flat bar armset, trimplate body, cap and PA bracket. NO COVER | 2-5 | Silver                | <b>11730</b> | TS.9205DABC.FB.SE            | 10 |
|  TS.9205DABC Slimline architectural door closer combined unit with back check, delayed action, flat bar armset, semi-radius cover and PA bracket.                          | 2-5 | Silver                | <b>11758</b> | TS.9205DABC.SRFB.SESE        | 8  |
|   | 2-5 | Satin Nickel          | <b>11761</b> | TS.9205DABC.SRFB.SNPSNP      | 8  |
|   | 2-5 | Polished Nickel       | <b>11749</b> | TS.9205DABC.SRFB.PNPPNP      | 8  |
|   | 2-5 | Polished Brass        | <b>11754</b> | TS.9205DABC.SRFB.PVDPVD      | 8  |
|   | 2-5 | Satin Stainless Steel | <b>11764</b> | TS.9205DABC.SRFB.SSSSSS      | 8  |
|   | 2-5 | Polished Stainless    | <b>11752</b> | TS.9205DABC.SRFB.PSSPSS      | 8  |
|   | 2-5 | Antique Brass         | <b>11748</b> | TS.9205DABC.SRFB.ABAB        | 8  |
|   | 2-5 | Antique Copper        | <b>12136</b> | TS.9205DABC.SRFB.ACAC        | 8  |
|   | 2-5 | Satin Brass           | <b>11760</b> | TS.9205DABC.SRFB.SBSB        | 8  |
|   | 2-5 | Dark Bronze           | <b>12129</b> | TS.9205DABC.SRFB.DBDB        | 8  |
|   | 2-5 | Medium Bronze         | <b>12131</b> | TS.9205DABC.SRFB.MBMB        | 8  |
|   | 2-5 | Light Bronze          | <b>12130</b> | TS.9205DABC.SRFB.LBLB        | 8  |
|   | 2-5 | Weathered Bronze      | <b>12137</b> | TS.9205DABC.SRFB.WBWB        | 8  |
|   | 2-5 | Black                 | <b>11917</b> | TS.9205DABC.SRFB.RAL9011BK   | 8  |
|   | 2-5 | Marine 316            | <b>12095</b> | TS.9205DABC.SRFB.A3.316SMARS | 8  |
|   | 2-5 | Colour Coated         | <b>11916</b> | TS.9205DABC.SRFB.RAL*RAL*    | 8  |
|   | 2-5 | Oil Rubbed Bronze     | <b>12151</b> | TS.9205DABC.SRFB.ORBORB      | 8  |

| Description   | EN Size      | Finish             | Re-order Code | Product Code | Box Qty |
|---|--------------|--------------------|---------------|--------------|---------|
|  TS.9205 Mechanism including delayed action and back check (Infinitely variable power) | 2-5          | Silver             | <b>11733</b>  | TS.9205DABC  | 10      |
|  TS.9205 Mechanism including back check (Infinitely variable power)                    | 2-5          | Silver             | <b>11667</b>  | TS.9205BC    | 10      |
|  TS.9205 Mechanism only (Infinitely variable power)                                    | 2-5          | Silver             | <b>11601</b>  | TS.9205      | 10      |
|  TS.9000 Series semi radius cover   | -            | Silver             | <b>11317</b>  | SR.90.SE     | 25      |
|   |              | Satin Nickel       | <b>11318</b>  | SR.90.SNP    | 25      |
|   |              | Polished Nickel    | <b>11312</b>  | SR.90.PNP    | 25      |
|   |              | Polished Brass     | <b>11314</b>  | SR.90.PVD    | 25      |
|   |              | Satin Stainless    | <b>11319</b>  | SR.90.SSS    | 25      |
|   |              | Polished Stainless | <b>11313</b>  | SR.90.PSS    | 25      |
|   |              | Colour Coated      | <b>12020</b>  | SR.90.RAL    | 25      |
|   |              | Polished Brass     | <b>11311</b>  | SR.90.PB     | 25      |
|   |              | Antique Brass      | <b>11307</b>  | SR.90.AB     | 25      |
|   |              | Satin Brass        | <b>11316</b>  | SR.90.SB     | 25      |
|   |              | Medium Bronze      | <b>12128</b>  | SR.90.MB     | 25      |
|   |              | Dark Bronze        | <b>12126</b>  | SR.90.DB     | 25      |
|   |              | Light Bronze       | <b>12127</b>  | SR.90.LB     | 25      |
|   |              | Weathered Bronze   | <b>12135</b>  | SR.90.WB     | 25      |
|   |              | Oil Rubbed Bronze  | <b>12150</b>  | SR.90.ORB    | 25      |
| Antique Copper  | <b>12134</b> | SR.90.AC           | 25            |              |         |
|  TS.9205 Drop plate (Includes fixing kit)  | -            | Silver             | <b>11050</b>  | DP.95.SE     | 10      |
|   |              | Satin Nickel       | <b>11051</b>  | DP.95.SNP    | 10      |
|   |              | Polished Nickel    | <b>11048</b>  | DP.95.PNP    | 10      |
|   |              | Polished Brass     | <b>11049</b>  | DP.95.PVD    | 10      |
| TS.9000 Series fixings pack   | -            | Silver             | <b>11132</b>  | FIX.90.SE    | 100     |
| Shoe plate  | -            | Silver             | <b>11269</b>  | SP.1.SE      | 50      |
|   |              | Satin Nickel       | <b>11270</b>  | SPA.1.SNP    | 50      |
| Trim Plate  | -            | Silver             | <b>11342</b>  | TP.95.SE     | 100     |
| Mounting Plate  | -            | Silver             | <b>12032</b>  | MP.95.SE     | 50      |

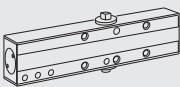
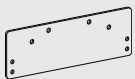























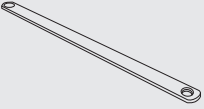



| Description  | EN Size                          | Finish                | Re-order Code         | Product Code                | Box Qty       |    |
|--|----------------------------------|-----------------------|-----------------------|-----------------------------|---------------|----|
| <b>TS.9206</b>   |                                  |                       |                       |                             |               |    |
| <b>WITH DELAYED ACTION AND BACK CHECK</b>  |                                  |                       |                       |                             |               |    |
|  <p>TS.9206 Slimline architectural door closer standard unit with back check, delayed action, flat type armset, trimplate body, cap and PA bracket.</p> | 2-6                              | Silver                | <b>11797</b>          | TS.9206DABC.FB.SE           | 6             |    |
|  | 2-6                              | Silver                | <b>11806</b>          | TS.9206DABC.SRFB3.SESE      | 6             |    |
|  <p>TS.9206 Slimline architectural door closer combined unit with back check, delayed action, flat bar armset, semi-radius cover and PA bracket.</p>    | 2-6                              | Satin Nickel          | <b>11807</b>          | TS.9206DABC.SRFB3.SNPSNP    | 6             |    |
|  | 2-6                              | Polished Nickel       | <b>11800</b>          | TS.9206DABC.SRFB3.PNPPNP    | 6             |    |
|  | 2-6                              | Polished Brass        | <b>11802</b>          | TS.9206DABC.SRFB3.PVDPVD    | 6             |    |
|  | 2-6                              | Satin Stainless Steel | <b>11809</b>          | TS.9206DABC.SRFB3.SSSSSS    | 6             |    |
|  | 2-6                              | Polished Stainless    | <b>11801</b>          | TS.9206DABC.SRFB3.PSSPSS    | 6             |    |
|  | 2-6                              | Black                 | <b>11931</b>          | TS.9206DABC.SRFB3.RAL9011BK | 6             |    |
|  | 2-6                              | Marine 316            | <b>12116</b>          | TS.9206DABC.SRFB3.MARS316   | 6             |    |
|  | 2-6                              | Colour Coated         | <b>11604</b>          | TS.9206DABC.SRFB3.RAL*RAL*  | 6             |    |
|  <p>TS.9206 Mechanism only including delayed action and back check (Infinitely variable power)</p>  | 2-6                              | Silver                | <b>11799</b>          | TS.9206DABC.FB3.SE          | 10            |    |
|  | -                                | Silver                | <b>11326</b>          | SR.96.SE                    | 25            |    |
|  | -                                | Satin Nickel          | <b>11327</b>          | SR.96.SNP                   | 25            |    |
|  | -                                | Polished Nickel       | <b>11321</b>          | SR.96.PNP                   | 25            |    |
|  | TS.9206 Series semi radius cover | -                     | Polished Brass        | <b>11323</b>                | SR.96.PVD     | 25 |
|  |                                  | -                     | Satin Stainless Steel | <b>11328</b>                | SR.96.SSS     | 25 |
|  |                                  | -                     | Polished Stainless    | <b>11322</b>                | SR.96.PSS     | 25 |
|  |                                  | -                     | Black                 | <b>12095</b>                | SR.96.RAL9011 | 25 |
|  |                                  | -                     | Marine 316            | <b>12115</b>                | SR.96.316S    | 25 |
|  |                                  | -                     | Silver                | <b>11054</b>                | DP.96.SE      | 10 |
|  <p>TS.9206 Drop plate (Includes fixing kit)</p>  | -                                | Satin Nickel          | <b>11055</b>          | DP.96.SNP                   | 10            |    |
|  | -                                | Polished Nickel       | <b>11052</b>          | DP.96.PNP                   | 10            |    |
|  | -                                | Polished Brass        | <b>11053</b>          | DP.96.PVD                   | 10            |    |
|  | -                                | Silver                | <b>11132</b>          | FIX.90.SE                   | 100           |    |
| TS.9000 Series fixings pack  | -                                | Silver                | <b>11132</b>          | FIX.90.SE                   | 100           |    |
| Mounting plate   | -                                | Silver                | <b>12033</b>          | MP.96.SE                    | 50            |    |
| Trim plate   | -                                | Silver                | <b>12122</b>          | TP.96.SE                    | 50            |    |
| Intumescent Kit for uninsulated steel doors  | -                                | -                     | <b>12406</b>          | IP.96M                      | 100           |    |

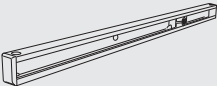

| Description                                     | EN Size | Finish       | Re-order Code | Product Code | Box Qty |
|---|---------|--------------|---------------|--------------|---------|
| <b>TS.24</b>                                    |         |              |               |              |         |
| TS.24 Combined unit (closer, slide arm, cover,) | 2-4     | Silver       | <b>12105</b>  | TS.24.SE     | 6       |
|   | 2-4     | Satin Nickel | <b>12106</b>  | TS.24.SNP    | 6       |
|   | 2-4     | White        | <b>12242</b>  | TS.24.WH     | 6       |
| Push Side Brackets                              | -       | Silver       | <b>11036</b>  | PSB.24.SE    |         |
|   |         | Satin Nickel | <b>11040</b>  | PSB.24.SNP   |         |
|   |         | White        | <b>11043</b>  | PSB.24.WH    |         |

|  |     |                    |              |                      |     |
|--|-----|--------------------|--------------|----------------------|-----|
| <b>TS.11204</b>  |     |                    |              |                      |     |
|  <p>TS.11204 cam action slide arm door closer combined unit (with SA.2 rail and connector bar - CB.5)</p> | 2-4 | Silver             | <b>11352</b> | TS.11204.SR.2.SESE   | 6   |
|  |     | Satin Nickel       | <b>11354</b> | TS.11204.SR.2.SNPSNP | 6   |
|  |     | Polished Nickel    | <b>11347</b> | TS.11204.SR.2.PNPPNP | 6   |
|  |     | Polished Brass     | <b>11349</b> | TS.11204.SR.2.PVDPVD | 6   |
|  |     | Antique Brass      | <b>12027</b> | TS.11204.SR.2.ABAB   | 6   |
|  |     | Black              | <b>11952</b> | TS.11204.SR.2.BK     | 6   |
|  |     | Colour Coated      | <b>11350</b> | TS.11204.SR.2.RALRAL | 6   |
|  <p>TS.11204 cam action with Square cover</p>   | 2-4 | Satin Nickel       | <b>11345</b> | TS.11204.SQ.2.SSSSNP | 6   |
|  <p>TS.11000 series semi radius cover</p>   | -   | Silver             | <b>11291</b> | SR.114.SE            | 25  |
|  |     | Satin Nickel       | <b>11292</b> | SR.114.SNP           | 25  |
|  |     | Polished Nickel    | <b>11289</b> | SR.114.PNP           | 25  |
|  |     | Polished Brass     | <b>11290</b> | SR.114.PVD           | 25  |
|  |     | Antique Brass      | <b>12025</b> | SR.114.AB            | 25  |
|  |     | Black              | <b>11433</b> | SR.114.BK            | 25  |
|  <p>TS11204 concealed door closer-to-slide arm connector bar options (single action not handed)</p>     | -   | Silver             | <b>11022</b> | CB.5.SE              | 50  |
|  |     | Satin Nickel       | <b>11023</b> | CB.5.SNP             | 50  |
|  |     | Polished Nickel    | <b>11020</b> | CB.5.PNP             | 50  |
|  |     | Polished Brass     | <b>11021</b> | CB.5.PVD             | 50  |
|  |     | Antique Brass      | <b>12023</b> | CB.5.AB              | 50  |
|  |     | Black              | <b>11434</b> | CB.5.BK              | 50  |
|  <p>461mm long Slide Rail for surface or concealed fixing</p>   | -   | Silver             | <b>11247</b> | SA.2.SE              | 25  |
|  |     | Satin Nickel Plate | <b>11248</b> | SA.2.SNP             | 25  |
|  |     | Polished Nickel    | <b>11245</b> | SA.2.PNP             | 25  |
|  |     | Polished Brass     | <b>11246</b> | SA.2.PVD             | 25  |
|  |     | Antique Brass      | <b>12024</b> | SA.2.AB              | 35  |
|  |     | Black              | <b>11244</b> | SA.2.BK              | 35  |
| Fixing pack for the TS.11204   | -   | Satin Nickel       | <b>11958</b> | FIX.2.114.SNP        | 100 |
|  |     | Polished Brass     | <b>11957</b> | FIX.2.114.PVD        | 100 |
| Intumescent Kit for uninsulated steel doors  | -   | Black              | <b>12407</b> | IP.114SM             | 100 |





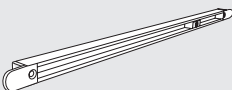

| Description  | EN Size | Finish   | Re-order Code | Product Code           | Box Qty |
|--|---------|--|---------------|------------------------|---------|
| <b>TS.11205</b>  |         |  |               |                        |         |
|  <p>TS.11205 cam action slide arm door closer combined unit (with SA.2 rail and connector bar - CB.5)</p> | 2-5     | Silver                | <b>12044</b>  | TS.11205.SR.2.SESE     | 6       |
|  |         | Satin Nickel          | <b>12045</b>  | TS.11205.SR.2.SNPSNP   | 6       |
|  |         | Polished Nickel       | <b>12042</b>  | TS.11205.SR.2.PNPPNP   | 6       |
|  |         | Polished Brass        | <b>12043</b>  | TS.11205.SR.2.PVDPVD   | 6       |
|  <p>TS.11204 cam action with Square cover, with delayed action</p>  | 2-5     | Silver                | <b>12157</b>  | TS.11205DA.SR.2.SESE   | 6       |
|  |         | Satin Nickel          | <b>12158</b>  | TS.11205DA.SR.2.SNPSNP | 6       |
|  <p>TS.11000 series semi radius cover</p>   | -       | Silver                | <b>11291</b>  | SR.115.SE              | 25      |
|  |         | Satin Nickel          | <b>11292</b>  | SR.115.SNP             | 25      |
|  |         | Polished Nickel       | <b>11289</b>  | SR.115.PNP             | 25      |
|  |         | Polished Brass        | <b>11290</b>  | SR.115.PVD             | 25      |
|  |         | Antique Brass         | <b>12025</b>  | SR.115.AB              | 25      |
|  <p>TS11205 concealed door closer-to-slide arm connector bar options (single action not handed)</p>       | -       | Silver                | <b>11022</b>  | CB.5.SE                | 50      |
|  |         | Satin Nickel          | <b>11023</b>  | CB.5.SNP               | 50      |
|  |         | Polished Nickel       | <b>11020</b>  | CB.5.PNP               | 50      |
|  |         | Polished Brass       | <b>11021</b>  | CB.5.PVD               | 50      |
|  |         | Antique Brass       | <b>12023</b>  | CB.5.AB                | 50      |
| Optional Mounting Bracket  | -       | -  | <b>11179</b>  | MP.114                 | 10      |
|  <p>461mm long Slide Rail for surface or concealed fixing</p>   |         | Silver              | <b>11247</b>  | SA.2.SE                | 25      |
|  |         | Satin Nickel Plate  | <b>11248</b>  | SA.2.SNP               | 25      |
|  |         | Polished Nickel     | <b>11245</b>  | SA.2.PNP               | 25      |
|  |         | Polished Brass      | <b>11246</b>  | SA.2.PVD               | 25      |
|  |         | Antique Brass       | <b>12024</b>  | SA.2.AB                | 35      |
| Fixing pack for the TS.11204   |         | Satin Nickel        | <b>11958</b>  | FIX.2.115.SNP          | 100     |
| Intumescent Kit for uninsulated steel doors  |         | Black               | <b>12407</b>  | IP.115SM               | 100     |

| Description  | EN Size | Finish          | Re-order Code | Product Code      | Box Qty |
|--|---------|-----------------|---------------|-------------------|---------|
| <b>ITS.11204</b>   |         |                 |               |                   |         |
|  <p>Single Action-ITS.11204 concealed standard rail slide arm door closer</p> | 2-4     | Silver          | <b>11172</b>  | ITS.11204.2.5.SE  | 10      |
|  |         | Satin Nickel    | <b>11173</b>  | ITS.11204.2.5.SNP | 10      |
|  |         | Polished Nickel | <b>11170</b>  | ITS.11204.2.5.PNP | 10      |
|  |         | Polished Brass  | <b>11171</b>  | ITS.11204.2.5.PVD | 10      |
|  |         | Antique Brass   | <b>12026</b>  | ITS.11204.2.5.AB  | 10      |
|  |         | Satin Brass     | <b>12521</b>  | ITS.11204.2.5.SB  | 10      |
|  |         | Black           | <b>12199</b>  | ITS.11204.2.5.BK  | 10      |

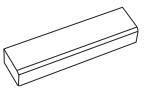

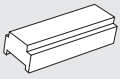





|  |     |                 |              |            |     |
|--|-----|-----------------|--------------|------------|-----|
|  <p>ITS.11204 Mechanism only</p>  | 2-4 | Silver          | <b>11165</b> | ITS.11204  | 10  |
|  <p>ITS.11204 concealed door closer-to-slide arm complete with single action connector bar - CB.5</p> | -   | Silver          | <b>12001</b> | SA.2.5.SE  | 25  |
|  |     | Satin Nickel    | <b>12002</b> | SA.2.5.SNP | 25  |
|  |     | Polished Nickel | <b>11998</b> | SA.2.5.PNP | 25  |
|  |     | Polished Brass  | <b>11999</b> | SA.2.5.PVD | 25  |
| Standard Rail Intumescent Pack   | -   | -               | <b>11161</b> | IP.114     | 100 |

|  |     |                 |              |                   |     |
|--|-----|-----------------|--------------|-------------------|-----|
| <b>ITS.11205</b>   |     |                 |              |                   |     |
|  <p>SINGLE ACTION ITS.11205 concealed slide arm door closer Combined unit (with SA.2 rail and connector bar - CB.5)</p> | 2-5 | Silver          | <b>12048</b> | ITS.11205.2.5.SE  | 10  |
|  |     | Satin Nickel    | <b>12049</b> | ITS.11205.2.5.SNP | 10  |
|  |     | Polished Nickel | <b>12046</b> | ITS.11205.2.5.PNP | 10  |
|  |     | Black           | <b>12216</b> | ITS.11205.2.5.BK  | 10  |
|  |     | Polished Brass  | <b>12047</b> | ITS.11205.2.5.PVD | 10  |
|  <p>ITS.11205 concealed door closer-to-slide arm complete with single action connector bar - CB.5</p>                   | -   | Silver          | <b>12001</b> | SA.2.5.SE         | 25  |
|  |     | Satin Nickel    | <b>12002</b> | SA.2.5.SNP        | 25  |
|  |     | Polished Nickel | <b>11998</b> | SA.2.5.PNP        | 25  |
|  |     | Polished Brass  | <b>11999</b> | SA.2.5.PVD        | 25  |
| Intumescent Pack   | -   | -               | <b>12151</b> | IP.115            | 100 |





| Description  | EN Size | Finish          | Re-order Code | Product Code      | Box Qty |
|--|---------|-----------------|---------------|-------------------|---------|
| <b>ITS.11204.3.5</b>   |         |                 |               |                   |         |
|  <p>ITS.11004 -concealed micro rail slide arm door closer</p>           | 2-4     | Silver          | <b>11420</b>  | ITS.11004.3.5.SE  | 10      |
|  |         | Satin Nickel    | <b>11421</b>  | ITS.11004.3.5.SNP | 10      |
|  |         | Polished Nickel | <b>11418</b>  | ITS.11004.3.5.PNP | 10      |
|  |         | Polished Brass  | <b>11419</b>  | ITS.11004.3.5.PVD | 10      |
|  <p>SINGLE ACTION – ITS.11004 concealed door closer mechanism only.</p> | 2-4     | Silver          | <b>11165</b>  | ITS.11004         | 10      |
|  <p>Micro slide rail complete with connector bar</p>                    | -       | Silver          | <b>11300</b>  | SA.3.5.SE         | 50      |
|  |         | Satin Nickel    | <b>11301</b>  | SA.3.5.SNP        | 50      |
|  |         | Polished Nickel | <b>11298</b>  | SA.3.5.PNP        | 50      |
|  |         | Polished Brass  | <b>11299</b>  | SA.3.5.PVD        | 50      |
| Micro Rail Mounting Frame  | -       | -               | <b>12030</b>  | SA.3.MF           | 25      |
|  <p>Micro Rail Cushion Stop</p>   | -       | White           | <b>12140</b>  | SA.CS.M           | 50      |
|  <p>Micro Rail Hold Open Device</p>                                    | -       | Silver          | <b>12138</b>  | SA.HO.M           | 50      |
| Intumescent Pack   | -       | -               | <b>11955</b>  | IP.114M           | 250     |

**ITS.H3**

|   |   |                 |              |               |    |
|---|---|-----------------|--------------|---------------|----|
| Hold Open Concealed Floor Spring Pivot c/w SS Cover and Top Pivot     | 3 | Stainless Steel | <b>12515</b> | ITS.H3.HO.SS  | 10 |
| Non-Hold Open Concealed Floor Spring Pivot c/w SS Cover and Top Pivot | 3 | Stainless Steel | <b>12516</b> | ITS.H3.NHO.SS | 10 |

| Description   | EN Size | Finish                               | Re-order Code   | Product Code | Box Qty   |              |
|---|---------|--------------------------------------|---|--------------|---|--------------|
| <b>Responder 24</b>   |         |                                      |   |              |   |              |
|  <p>Responder 24<br/>Electromagnetic Door Closer</p> | 4       | Silver                               |  | <b>10912</b> | ETS.18314.SE  | 4            |
|   |         | Satin Nickel                         |  | <b>10913</b> | ETS.18314.SNP   | 4            |
|   |         | Polished Nickel                      |  | <b>10910</b> | ETS.18314.PNP   | 4            |
|   |         | Polished Brass                       |  | <b>10909</b> | ETS.18314.PVD   | 4            |
|   |         | Antique Brass                        |  | <b>12193</b> | ETS.18314.AB  | 4            |
|   |         | Black                                |  | <b>12409</b> | IP.RESPONDER.M  | 100          |
|   |         | Extension Wire and Black Box (600mm) | -   | Black        |  | <b>11944</b> |

| Description  | EN Size | Finish       | Re-order Code  | Product Code |                     |
|--|---------|--------------|--|--------------|---------------------|
| <b>Firetrak.114</b>  |         |              |  |              |                     |
|  <p>Electromagnetic slide arm door closer</p> | 2-4     | Silver       |  | <b>12446</b> | TS.FIRETRAK.114.SE  |
|  |         | Satin Nickel |  | <b>12447</b> | TS.FIRETRAK.114.SNP |
| Anti-Ligature Fixing Bolt for Connector Bar  | -       | Black        |  | <b>12075</b> | FIX.AL              |
| Intumescent for uninsulated steel doors  | -       | Black        |  | <b>12462</b> | IP.FIRETRAK.114SM   |

|  |     |              |  |              |                     |
|--|-----|--------------|--|--------------|---------------------|
| <b>Firetrak.115</b>  |     |              |  |              |                     |
|  <p>Electromagnetic slide arm door closer</p> | 2-4 | Silver       |  | <b>12448</b> | TS.FIRETRAK.115.SE  |
|  |     | Satin Nickel |  | <b>12449</b> | TS.FIRETRAK.115.SNP |
| Anti-Ligature Fixing Bolt for Connector Bar  | -   | Black        |  | <b>12075</b> | FIX.AL              |
| Intumescent for uninsulated steel doors  | -   | Black        |  | <b>12463</b> | IP.FIRETRAK.115SM   |

Description

EN Size

Finish

Re-order Code

Product Code

Box Qty

**TS.7000 - Hold Open**

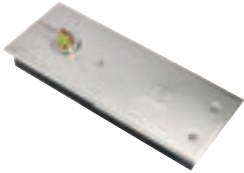



|   |   |   |                 |                                 |                  |                  |   |
|---|---|---|-----------------|---------------------------------|------------------|------------------|---|
| <p>TS.7003 combined unit hold open floor spring cover and action accessory pack</p> <p>TS.7004 combined unit hold open floor spring cover and action accessory pack</p> | <p>Double action</p> <p>Single action</p> | 3   | Stainless Steel |                                 | <b>11451</b>     | TS.7003HO.DAX.SS | 4 |
|   |   |   | Polished Brass  |                                 | <b>11450</b>     | TS.7003HO.DAX.PB | 4 |
|   |   |   | Antique Brass   |                                 | <b>12472</b>     | TS.7003HO.DAX.AB | 4 |
|   |   | Stainless Steel                           |                 | LH <b>11454</b> RH <b>11455</b> | TS.7003HO.SAX.SS | 4                |   |
|   |   | Polished Brass                            |                 | LH <b>11452</b> RH <b>11453</b> | TS.7003HO.SAX.PB | 4                |   |
|   |   | Antique Brass                             |                 | LH <b>12473</b> RH <b>12474</b> | TS.7003HO.SAX.AB | 4                |   |
|   | 4   | <p>Double action</p> <p>Single action</p> | Stainless Steel |                                 | <b>11465</b>     | TS.7004HO.DAX.SS | 4 |
|   |   |   | Polished Brass  |                                 | <b>11464</b>     | TS.7004HO.DAX.PB | 4 |
|   |   |   | Antique Brass   |                                 | <b>12475</b>     | TS.7004HO.DAX.AB | 4 |
|   |   | Stainless Steel                           |                 | LH <b>11468</b> RH <b>11469</b> | TS.7004HO.SAX.SS | 4                |   |
|   |   | Polished Brass                            |                 | LH <b>11466</b> RH <b>11467</b> | TS.7004HO.SAX.PB | 4                |   |
|   |   | Antique Brass                             |                 | LH <b>12476</b> RH <b>12477</b> | TS.7004HO.SAX.AB | 4                |   |





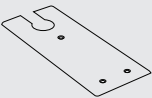
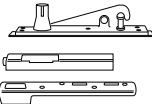
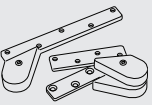
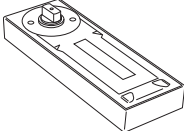

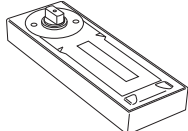
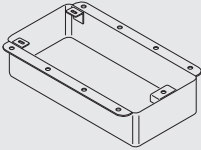
**TS.7000 - Non Hold Open**



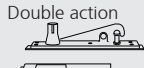

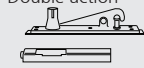
|   |   |   |                 |                                 |                   |                   |   |
|---|---|---|-----------------|---------------------------------|-------------------|-------------------|---|
| <p>TS.7003 combined unit hold open floor spring cover and action accessory pack</p> <p>TS.7004 combined unit hold open floor spring cover and action accessory pack</p> | <p>Double action</p> <p>Single action</p> | 3   | Stainless Steel |                                 | <b>11458</b>      | TS.7003NHO.DAX.SS | 4 |
|   |   |   | Polished Brass  |                                 | <b>11457</b>      | TS.7003NHO.DAX.PB | 4 |
|   |   |   | Antique Brass   |                                 | <b>12481</b>      | TS.7003NHO.DAX.AB | 4 |
|   |   | Stainless Steel                           |                 | LH <b>11461</b> RH <b>11462</b> | TS.7003NHO.SAX.SS | 4                 |   |
|   |   | Polished Brass                            |                 | LH <b>11459</b> RH <b>11460</b> | TS.7003NHO.SAX.PB | 4                 |   |
|   |   | Antique Brass                             |                 | LH <b>12482</b> RH <b>12483</b> | TS.7003NHO.SAX.AB | 4                 |   |
|   | 4   | <p>Double action</p> <p>Single action</p> | Stainless Steel |                                 | <b>11472</b>      | TS.7004NHO.DAX.SS | 4 |
|   |   |   | Polished Brass  |                                 | <b>11471</b>      | TS.7004NHO.DAX.PB | 4 |
|   |   |   | Antique Brass   |                                 | <b>12484</b>      | TS.7004NHO.DAX.AB | 4 |
|   |   | Stainless Steel                           |                 | LH <b>11468</b> RH <b>11469</b> | TS.7004NHO.SAX.SS | 4                 |   |
|   |   | Polished Brass                            |                 | LH <b>11466</b> RH <b>11467</b> | TS.7004NHO.SAX.PB | 4                 |   |
|   |   | Antique Brass                             |                 | LH <b>12485</b> RH <b>12486</b> | TS.7004NHO.SAX.AB | 4                 |   |

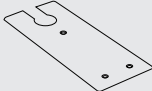
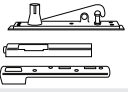
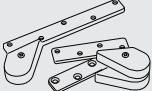
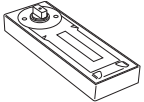

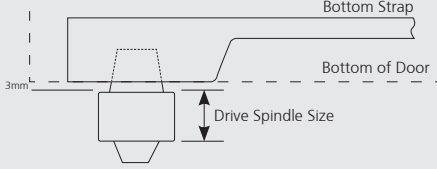
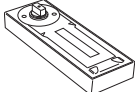
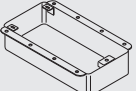
| Description   | EN Size    | Finish   | Re-order Code | Product Code | Box Qty   |
|---|------------|--|---------------|--------------|-----------|
| <b>TS7000 product codes continued</b>   |            |  |               |              |           |
|  TS.7000 Cover plate   | -          | Stainless Steel                                    | <b>11027</b>  | CP.70.SS     | 25        |
|   |            | Polished Brass                                     | <b>11025</b>  | CP.70.PB     | 25        |
|   |            | Antique Brass                                      | <b>12092</b>  | CP.70.AB     | 25        |
|  TS.7000 Double action accessory pack  | -          | Stainless Steel, Polished Brass and Antique Brass* | <b>11221</b>  | PS.180.SS.PB | 10        |
|   |            |  |               | <b>12487</b> | PS.180.AB |
|  T.S7000 Single action accessory pack  | Left hand  | Stainless Steel                                    | <b>11218</b>  | PS.170L.SS   | 10        |
|   | Left hand  | Polished Brass                                     | <b>11216</b>  | PS.170L.PB   | 10        |
|   | Left hand  | Antique Brass                                      | <b>12489</b>  | PS.170L.AB   | 10        |
|   | Right hand | Stainless Steel                                    | <b>11220</b>  | PS.170R.SS   | 10        |
|   | Right hand | Polished Brass                                     | <b>11219</b>  | PS.170R.PB   | 10        |
|   | Right hand | Antique Brass                                      | <b>12488</b>  | PS.170R.AB   | 10        |
| TS.7002 Hold open body only c/w cement box  | 2          | -  | <b>11435</b>  | TS.7002HO    | 4         |
| TS.7002 Non hold open body only c/w cement box  | 2          | -  | <b>11442</b>  | TS.7002NHO   | 4         |
|  TS.7003 Hold open body only c/w cement box  | 3          | -  | <b>11449</b>  | TS.7003HO    | 4         |
|   | 3          | -  | <b>11456</b>  | TS.7003NHO   | 4         |
| TS.7004 Hold open body only c/w cement box  | 4          | -  | <b>11463</b>  | TS.7004HO    | 4         |
| TS7004 Non hold open body only c/w cement box   | 4          | -  | <b>11470</b>  | TS.7004NHO   | 4         |
|  Drive spindles for TS.7000 floor springs 3, 5, 8, 10, 13, 15, 18, 23, 28, 33, 48mm (8mm supplied as standard) | 3          | YPAS   | <b>11081</b>  | DS.70.3      | 50        |
|   | 5          | YPAS   | <b>11082</b>  | DS.70.5      | 50        |
|   | 8          | YPAS   | <b>11083</b>  | DS.70.8      | 50        |
|   | 10         | YPAS   | <b>11075</b>  | DS.70.10     | 50        |
|   | 13         | YPAS   | <b>11076</b>  | DS.70.13     | 50        |
|   | 15         | YPAS   | <b>11077</b>  | DS.70.15     | 50        |
|   | 18         | YPAS   | <b>11078</b>  | DS.70.18     | 50        |
|   | 23         | YPAS   | <b>11079</b>  | DS.70.23     | 50        |
|   | 28         | YPAS   | <b>11080</b>  | DS.70.28     | 50        |
|   | 33         | YPAS   | <b>11857</b>  | DS.70.33     | 50        |
| 48  | YPAS       | <b>11819</b>                                       | DS.70.48      | 50           |           |
|  TS.7000 Dummy floor spring  | -          | -  | <b>11942</b>  | DF.70.SS     | 4         |
|  Hollow floor mounting cradle for floor spring 108W x 306L x 40H   | -          | Black  | <b>11151</b>  | HMC.70       | 25        |
| Intumescent kit for TS.7000   | -          | -  | <b>11164</b>  | IP.190       | 100       |

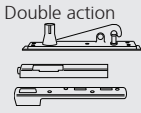
\*If Polished Brass to state on the order

| Description  | EN Size  | Finish                             | Re-order Code   | Product Code                    | Box Qty           |   |
|--|--|------------------------------------|-----------------|---------------------------------|-------------------|---|
| <b>TS.7104 - Hold Open</b>   |  |                                    |                 |                                 |                   |   |
|  <p>TS.7104 combined unit</p>   | <br> | 1-4                                | Stainless Steel | <b>11893</b>                    | TS.7104HO.DAX.SS  | 4 |
|  |  |                                    | Polished Brass  | <b>11892</b>                    | TS.7104HO.DAX.PB  | 4 |
|  |  |                                    | Stainless Steel | LH <b>11896</b> RH <b>11897</b> | TS.7104HO.SAX.SS  | 4 |
|  |  |                                    | Polished Brass  | LH <b>11894</b> RH <b>11895</b> | TS.7104HO.SAX.PB  | 4 |
| <b>TS.7104 - Non Hold Open</b>   |  |                                    |                 |                                 |                   |   |
|  <p>TS.7104 combined unit</p>   | <br> | 1-4                                | Stainless Steel | <b>11899</b>                    | TS.7104NHO.DAX.SS | 4 |
|  |  |                                    | Polished Brass  | <b>11898</b>                    | TS.7104NHO.DAX.PB | 4 |
|  |  |                                    | Stainless Steel | LH <b>11902</b> RH <b>11903</b> | TS.7104NHO.SAX.SS | 4 |
|  |  |                                    | Polished Brass  | LH <b>11900</b> RH <b>11901</b> | TS.7104NHO.SAX.PB | 4 |
| <b>TS.7104</b>   |  |                                    |                 |                                 |                   |   |
|  <p>TS.7104 Cover plate</p>  | -  | Stainless Steel                    | <b>11941</b>    | CP.74.SS                        | 25                |   |
|  |  | Polished Brass                     | <b>11940</b>    | CP.74.PB                        | 25                |   |
|  <p>TS.7104 Double action accessory pack</p>  | -  | Stainless Steel and Polished Brass | <b>12057</b>    | PS.190.SS.PB                    | 10                |   |
|  <p>TS.7104 Single action accessory pack</p>  | Left hand  | Stainless Steel                    | <b>11218</b>    | PS.170L.SS                      | 10                |   |
|  | Left hand  | Polished Brass                     | <b>11216</b>    | PS.170L.PB                      | 10                |   |
|  | Right hand   | Stainless Steel                    | <b>11220</b>    | PS.170R.SS                      | 10                |   |
|  | Right hand   | Polished Brass                     | <b>11219</b>    | PS.170R.PB                      | 10                |   |
|  <p>TS.7104 Hold open body only c/w cement box</p>  | 4  | -                                  | <b>11862</b>    | TS.7104HO                       | 4                 |   |
|  <p>TS.7104 Non hold open body only c/w cement box</p>  | 4  | -                                  | <b>11855</b>    | TS.7104NHO                      | 4                 |   |
|  <p>Drive spindles for TS.7104 floor springs 3, 5, 8, 10, 13, 15, 18, 23, 48mm (8mm supplied as standard)</p>  | 3  | YPAS                               | <b>11081</b>    | DS.70.3                         | 50                |   |
|  | 5  | YPAS                               | <b>11082</b>    | DS.70.5                         | 50                |   |
|  | 8  | YPAS                               | <b>11083</b>    | DS.70.8                         | 50                |   |
|  | 10   | YPAS                               | <b>11075</b>    | DS.70.10                        | 50                |   |
|  | 13   | YPAS                               | <b>11076</b>    | DS.70.13                        | 50                |   |
|  | 15   | YPAS                               | <b>11077</b>    | DS.70.15                        | 50                |   |
|  | 18   | YPAS                               | <b>11078</b>    | DS.70.18                        | 50                |   |
|  | 23   | YPAS                               | <b>11079</b>    | DS.70.23                        | 50                |   |
|  | 28   | YPAS                               | <b>11080</b>    | DS.70.28                        | 50                |   |
|  | 33   | YPAS                               | <b>11857</b>    | DS.70.33                        | 50                |   |
| 48   | YPAS   | <b>11819</b>                       | DS.70.48        | 50                              |                   |   |
|  <p>TS.7104 Dummy floor spring</p>  | -  | -                                  | <b>11942</b>    | DF.70.SS                        | 4                 |   |
|  <p>Hollow floor mounting cradle for floor spring 275L x 80W x 50H</p>  | -  | Black                              | <b>11974</b>    | HMC.74                          | 25                |   |
| Intumescent kit for TS7104   | -  | -                                  | <b>11164</b>    | IP.70                           | 100               |   |

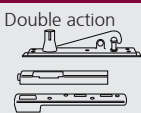
| Description  | EN Size  | Finish | Re-order Code   | Product Code | Box Qty          |   |
|--|--|--------|-----------------|--------------|------------------|---|
| <b>TS.7306 - Hold Open</b>   |  |        |                 |              |                  |   |
|  <p>Heavy Duty Floor Spring</p> |  <p>Double action</p> | 3-6    | Stainless Steel | <b>12102</b> | TS.7306HO.DAX.SS | 4 |
|  | Body & Cover only  | 3-6    | Stainless Steel | <b>12101</b> | TS.7306HO.SS     | 4 |

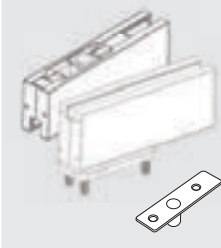
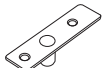

|  |  |     |                 |              |                   |   |
|--|--|-----|-----------------|--------------|-------------------|---|
| <b>TS.7306 - Non Hold Open</b>   |  |     |                 |              |                   |   |
|  <p>Heavy Duty Floor Spring</p> |  <p>Double action</p> | 3-6 | Stainless Steel | <b>12104</b> | TS.7306NHO.DAX.SS | 4 |
|  | Body & Cover only  | 3-6 | Stainless Steel | <b>12103</b> | TS.7306NHO.SS     | 4 |

|   |   |   |                 |              |             |   |
|---|---|---|-----------------|--------------|-------------|---|
| <b>GP.3</b>   |   |   |                 |              |             |   |
|  | Glass Patch Closer CW Closer, Top Patch & Pivot Hold Open     | 3 | Satin Stainless | <b>12143</b> | GP.3HO.KIT  | 6 |
|   | Glass Patch Closer  | 3 | Satin Stainless | <b>12078</b> | GP.3HO.SSS  | 6 |
|   | Glass Patch Closer CW Closer, Top Patch & Pivot Non Hold Open | 3 | Satin Stainless | <b>12144</b> | GP.3NHO.KIT | 6 |
|   | Glass Patch Closer  | 3 | Satin Stainless | <b>12079</b> | GP.3NHO.SSS | 6 |
|  | Top Pivot   | - | Satin Stainless | <b>12088</b> | TP.1.SSS    | 6 |
|  | Top Pivot Patch   | - | Satin Stainless | <b>12084</b> | GP.2.SSS    | 6 |











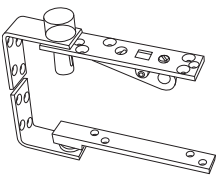



|   |   |     |                 |              |              |   |
|---|---|-----|-----------------|--------------|--------------|---|
| <b>GP.35</b>  |   |     |                 |              |              |   |
|  | Glass Patch Closer CW Closer, Top Patch & Pivot Hold Open     | 3-5 | Satin Stainless | <b>12145</b> | GP.35HO.KIT  | 6 |
|   | Glass Patch Closer  | 3-5 | Satin Stainless | <b>12082</b> | GP.35HO.SSS  | 6 |
|   | Glass Patch Closer CW Closer, Top Patch & Pivot Non Hold Open | 3-5 | Satin Stainless | <b>12146</b> | GP.35NHO.KIT | 6 |
|   | Glass Patch Closer  | 3-5 | Satin Stainless | <b>12083</b> | GP.35NHO.SSS | 6 |
|  | Top Pivot   | -   | Satin Stainless | <b>12088</b> | TP.1.SSS     | 6 |
|  | Top Pivot Patch   | -   | Satin Stainless | <b>12084</b> | GP.2.SSS     | 6 |

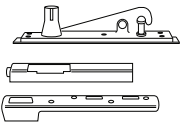

| Description   | EN Size   | Load Kit           | Re-order Code | Product Code   | Box Qty    |     |
|---|---|--------------------|---------------|----------------|------------|-----|
| <b>TS.8000 - Hold Open</b>  |   |                    |               |                |            |     |
|    | TS.8002 Concealed transom closer                      | with end load set  | <b>11477</b>  | TS.8002HO.ELA  | 4          |     |
|   |   | with side load set | <b>11478</b>  | TS.8002HO.SLA  | 4          |     |
|   | TS.8003 Concealed transom closer                      | with end load set  | <b>11485</b>  | TS.8003HO.ELA  | 4          |     |
|   |   | with side load set | <b>11486</b>  | TS.8003HO.SLA  | 4          |     |
|   | TS.8004 Concealed transom closer                      | with end load set  | <b>11493</b>  | TS.8004HO.ELA  | 4          |     |
|   |   | with side load set | <b>11494</b>  | TS.8004HO.SLA  | 4          |     |
| <b>TS.8000 - Non Hold Open</b>  |   |                    |               |                |            |     |
|   | TS.8002 Concealed transom closer                      | with end load set  | <b>11481</b>  | TS.8002NHO.ELA | 4          |     |
|   |   | with side load set | <b>11482</b>  | TS.8002NHO.SLA | 4          |     |
|   | TS.8003 Concealed transom closer                      | with end load set  | <b>11489</b>  | TS.8003NHO.ELA | 4          |     |
|   |   | with side load set | <b>11490</b>  | TS.8003NHO.SLA | 4          |     |
|   | TS.8004 Concealed transom closer                      | with end load set  | <b>11497</b>  | TS.8004NHO.ELA | 4          |     |
|   |   | with side load set | <b>11498</b>  | TS.8004NHO.SLA | 4          |     |
|  | End load arm set                                      | -                  | -             | <b>11057</b>   | ELA.80     | 50  |
|  | Side load arm set                                     | -                  | -             | <b>11265</b>   | SLA.80     | 50  |
|  | TS.8000 Dummy body only C/W brackets                  | -                  | -             | <b>11056</b>   | DT.80      | 4   |
|   | TS.8002 Body only - Light C/W brackets Hold Open      | 2                  | -             | <b>11476</b>   | TS8002.HO  | 4   |
|   | TS.8002 Body only - Light C/W brackets Non Hold Open  | 2                  | -             | <b>11480</b>   | TS8002.NHO | 4   |
|   | TS.8003 Body only - Medium C/W brackets Hold Open     | 3                  | -             | <b>11484</b>   | TS8003.HO  | 4   |
|   | TS.8003 Body only - Medium C/W brackets Non Hold Open | 3                  | -             | <b>11488</b>   | TS8003.NHO | 4   |
|   | TS.8004 Body only - Heavy C/W brackets Hold Open      | 4                  | -             | <b>11492</b>   | TS8004.HO  | 4   |
|   | TS.8004 Body only - Heavy C/W brackets Non Hold Open  | 4                  | -             | <b>11496</b>   | TS8004.NHO | 4   |
|   | TS.8000 Series fixing pack (bottom bearing only)      |                    |               | <b>11130</b>   | FIX.80.SE  | 100 |
|  | Cover for wood frames<br>Satin Stainless finish       | -                  | -             | <b>11028</b>   | CP.80.SS   | 25  |

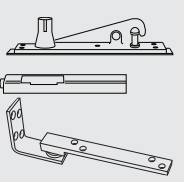
| Description  | Finish   | Re-order Code | Product Code | Box Qty |
|--|--|---------------|--------------|---------|
| <b>DR.11000</b>  |  |               |              |         |
|  Restrictor Stay    | Silver        | <b>11417</b>  | DR.11000.SE  | 10      |
|  | Satin Nickel  | <b>12169</b>  | DR.11000.SNP | 10      |
|  Cushion stop       | -  | <b>12140</b>  | SA.CS.M      | 10      |
|  Hold open facility | -  | <b>12138</b>  | SA.HO.M      | 10      |

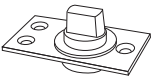
**Pivot Sets**

|  |  |              |              |    |
|--|--|--------------|--------------|----|
|  Pivot set with adjustable top centre, bottom strap and door frame fixing bracket (ø12mm) | Satin Stainless Steel                 | <b>11215</b> | PS.100       | 10 |
|  (Left hand) Single action top & bottom centre pivot                                    | Stainless Steel                     | <b>11218</b> | PS.170L.SS   | 10 |
|  | Polished Brass                      | <b>11216</b> | PS.170L.PB   | 10 |
|  (Right hand) Single action top & bottom centre pivot                                   | Stainless Steel                     | <b>11220</b> | PS.170R.SS   | 10 |
|  | Polished Brass                      | <b>11219</b> | PS.170R.PB   | 10 |
|  Double Action Pivot Set  | Stainless Steel and Polished Brass  | <b>12057</b> | PS.190.SS.PB | 10 |
|  Double Action Pivot  | Stainless Steel                     | <b>12511</b> | PS.190100.SS | 10 |
|  Floor Mount Spindle  | Satin Stainless Steel               | <b>11226</b> | PS.260.SSS   | 10 |





| Description   | Finish          | Re-order Code | Product Code | Box Qty |
|---|-----------------|---------------|--------------|---------|
| <b>Emergency Release Stop</b>   |                 |               |              |         |
|  Emergency release door stop | Stainless Steel | <b>11338</b>  | TH.106       | 50      |
| Emergency release door stop   | Stainless Steel | <b>11339</b>  | TH.107       | 50      |

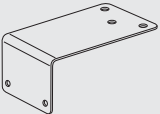
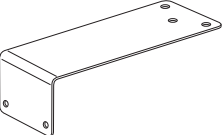
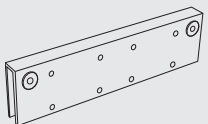
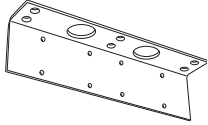
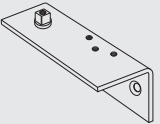
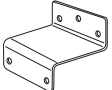
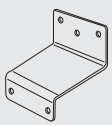

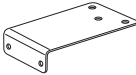
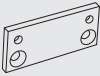
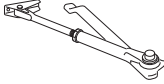
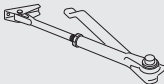
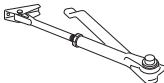
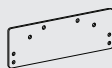

### Power Supply Unit

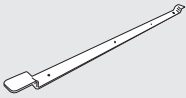

|   |                     |                |          |   |
|---|---------------------|----------------|----------|---|
|  2 amp 4 way 24VDC | White Powder Coated | <b>12160</b>   | PSU.1222 | 1 |
| 4 amp 4 way 24VDC   | White Powder Coated | <b>12160/4</b> | PSU.1224 | 1 |

| Description  | Finish                | Re-order Code | Product Code | Box Qty |
|--|-----------------------|---------------|--------------|---------|
|  Extended parallel arm bracket (includes fixings)          | Silver                | <b>11195</b>  | PAB.2.SE     | 50      |
|  | Black                 | <b>11189</b>  | PAB.2.BK     | 50      |
|  | Gold                  | <b>11190</b>  | PAB.2.GE     | 50      |
|  | Satin Nickel          | <b>11196</b>  | PAB.2.SNP    | 50      |
|  | Polished Nickel       | <b>11191</b>  | PAB.2.PNP    | 50      |
|  | Polished Brass        | <b>11193</b>  | PAB.2.PVD    | 50      |
|  | Colour Coated         | <b>11194</b>  | PAB.2.RAL    | 50      |
|  Extra long parallel arm bracket (includes fixings)       | Silver                | <b>11982</b>  | PAB.18.SE    | 50      |
|  | Black                 | <b>11978</b>  | PAB.18.BK    | 50      |
|  | Gold                  | <b>11979</b>  | PAB.18.GE    | 50      |
|  | Satin Nickel          | <b>11983</b>  | PAB.18.SNP   | 50      |
|  | Polished Nickel       | <b>11980</b>  | PAB.18.PNP   | 50      |
|  | Polished Brass        | <b>11981</b>  | PAB.18.PVD   | 50      |
|  | Colour Coated         |               | PAB.18.RAL   | 50      |
|  Glass door shoe to suit glass (10mm) - Pull side fitting | Silver                | <b>11141</b>  | GDS.95.SE    | 10      |
|  Soffit mounting bracket                                  | Silver                | <b>11268</b>  | SMB.95.SE    | 100     |
|  Pinion bracket   | Silver                | <b>11214</b>  | PIN.SE       | 50      |
|  Z Bracket  | Silver                | <b>11205</b>  | PAB.5.SE     | 50      |
|  | Satin Stainless Steel | <b>11206</b>  | PAB.5.SSS    | 50      |
|  Angled Z Bracket   | Silver                | <b>11209</b>  | PAB.6.SE     | 50      |

| Description  | Finish             | Code       | Re-order Code | Products Applicable       | Box Qty |
|--|--------------------|------------|---------------|---------------------------|---------|
| <b>Universal Door Closer Components</b>  |                    |            |               |                           |         |
|  <p>Star Cut Screw Type Armset (includes fixings &amp; PA bracket)</p>            | Silver             | STA.3.SE   | 11337         | TS.3204, TS.9205, TS.9206 | 25      |
|  | Satin Stainless    | FBA.1.SSS  | 11093         | TS.3204, TS.9205,         | 25      |
|  <p>Standard Flat Bar armset (includes fixings &amp; PA bracket)</p>              | Silver             | FBA.1.SE   | 11091         | TS.3204, TS.5204, TS.9205 | 25      |
|  | Satin Nickel       | FBA.1.SNP  | 11092         | TS.3204, TS.5204, TS.9205 | 25      |
|  | Polished Nickel    | FBA.1.PNP  | 11087         | TS.3204, TS.5204, TS.9205 | 25      |
|  | Polished Brass     | FBA.1.PVD  | 11089         | TS.3204, TS.5204, TS.9205 | 25      |
|  | Satin Brass        | FBA.1.SB   | 11090         | TS.3204, TS.9205          | 25      |
|  | Black              | FBA.1.BK   | 11085         | TS.5204, TS.9205          | 25      |
|  | Polished Stainless | FBA.1.PSS  | 11088         | TS.9205                   | 25      |
|  | Antique Brass      | FBA.1.AB   | 11084         | TS.9205                   | 25      |
|  | Antique Copper     | FBA.1.AC   | 12132         | TS.9205                   | 25      |
|  | Dark Bronze        | FBA.1.DB   | 12123         | TS.9205                   | 25      |
|  | Medium Bronze      | FBA.1.MB   | 12125         | TS.9205                   | 25      |
|  | Light Bronze       | FBA.1.LB   | 12124         | TS.9205                   | 25      |
|  | Weathered Bronze   | FBA.1.WB   | 12133         | TS.9205                   | 25      |
|  | Colour Coated      | FBA.1.RAL  | 11956         | TS.9205                   | 25      |
| Oil Rubbed Bronze  | FBA.1.ORB          | 12149      | TS.9205       | 25                        |         |
|  <p>Standard Flat Bar Armset (star-cut) (includes fixings &amp; PA bracket)</p> | Silver             | FBA.3.SE   | 11105         | TS.9206                   | 25      |
|  | Black              | FBA.3.BK   | 11101         | TS.9206                   | 25      |
|  | Satin Nickel       | FBA.3.SNP  | 11106         | TS.9206                   | 25      |
|  | Polished Nickel    | FBA.3.PNP  | 11102         | TS.9206                   | 25      |
|  | Polished Brass     | FBA.3.PVD  | 11104         | TS.9206                   | 25      |
|  | Satin Stainless    | FBA.3.SSS  | 11107         | TS.9206                   | 25      |
|  | Polished Stainless | FBA.3.PSS  | 11103         | TS.9206                   | 25      |
|  | Marine 316         | FBA.3.MARS | 12094         | TS.9206                   | 25      |

| Description   | Finish             | Code       | Re-order Code | Products Applicable                                     | Box Qty |
|---|--------------------|------------|---------------|---|---------|
| <b>Universal Door Closer Components</b>   |                    |            |               |   |         |
|    | Silver             | PAB.1.SE   | 11186         | TS.3204, TS.5204, TS.9205                               | 50      |
|   | Satin Nickel       | PAB.1.SNP  | 11187         | TS.3204, TS.5204, TS.9205                               | 50      |
|   | Polished Nickel    | PAB.1.PNP  | 11182         | TS.3204, TS.5204, TS.9205                               | 50      |
|   | Polished Brass     | PAB.1.PVD  | 11184         | TS.3204, TS.5204, TS.9205                               | 50      |
|   | Black              | PAB.1.BK   | 11180         | TS.9205   | 50      |
|   | Satin Stainless    | PAB.1.SSS  | 11188         | TS.9205   | 50      |
|   | Polished Stainless | PAB.1.PSS  | 11183         | TS.9205   | 50      |
|    | Silver             | SP.1.SE    | 11269         | TS.3204, TS.5204  | 50      |
|   | Satin Nickel       | SP.1.SNP   | 11270         | TS.5204   | 50      |
|    | Silver             | HOA.1.SE   | 11152         | TS.3204   | 25      |
|   | Black              | HOA.1.BK   | 11975         | TS.3204   | 25      |
|   | Silver             | HOA.2.SE   | 11156         | TS.5204, TS.9205, TS.9206                               | 25      |
|   | Black              | HOA.2.BK   | 11155         | TS.5204, TS.9205, TS.9206                               | 25      |
|  | Silver             | HOPA.SE    | 11158         | TS.5204, TS.9205, TS.9206                               | 25      |
|   | Black              | HOPA.BK    | 11157         | TS.5204, TS.9205, TS.9206                               | 25      |
|  | Silver             | SA.DP.SE   | 12154         | TS.11204, TS.11205                                      | 25      |
|   | White              | SA.DP.WH   | 12007         | TS.11204, TS.11205                                      | 35      |
|  | -                  | SA.CS      | 11249         | TS.11204, TS.11205, ITS.11204, ITS.11205                | 25      |
|  | -                  | SA.1.BLOCK | 11236         | TS.11204, TS.11205, ITS.11204, ITS.11205, ITS.11204.3.5 | 25      |
|  | -                  | SA.HO      | 11251         | TS.11204, TS.11205, ITS.11204, ITS.11205                | 25      |
|  | Satin Nickel       | SAC.2.SNP  | 12238         | TS.11204, TS.11205                                      | 25      |
|  | Silver             | SA.2.MF    | 12029         | ITS.11204, ITS.11205                                    | 25      |

| Description  | Finish   | Re-order Code | Product Code    | Box Qty |
|--|--|---------------|-----------------|---------|
| <b>Din Locks</b>   |  |               |                 |         |
|  DIN Standard Dead Lock<br>Backset size 55mm      | Stainless Steel - Square   | <b>50339</b>  | RDL.DL.55.SSSQ  | 10      |
|  | Stainless Steel - Radius   | <b>50340</b>  | RDL.DL.55.SSR   | 10      |
|  | Lock Intumescent Kit - suits 55/65mm backset sizes, both square and radius Din locks | <b>12535</b>  | IP.DL           | 100     |
|  DIN Standard Euro Sash Lock<br>Backset size 55mm | Stainless Steel - Square   | <b>50331</b>  | RDL.ESL.55.SSSQ | 10      |
|  | Stainless Steel - Radius   | <b>50332</b>  | RDL.ESL.55.SSR  | 10      |
|  | Lock Intumescent Kit - suits 55/65mm backset sizes, both square and radius Din locks | <b>12535</b>  | IP.DL           | 100     |
|  DIN Bathroom Lock<br>Backset size 55mm           | Stainless Steel - Square   | <b>50341</b>  | RDL.BL.55.SSSQ  | 10      |
|  | Stainless Steel - Radius   | <b>50342</b>  | RDL.BL.55.SSR   | 10      |
|  | Lock Intumescent Kit - suits 55/65mm backset sizes, both square and radius Din locks | <b>12535</b>  | IP.DL           | 100     |
|  DIN Standard Latch<br>Backset size 55mm         | Stainless Steel - Square   | <b>50335</b>  | RDL.L.55.SSSQ   | 10      |
|  | Stainless Steel - Radius   | <b>50336</b>  | RDL.L.55.SSR    | 10      |
|  | Lock Intumescent Kit - suits 55/65mm backset sizes, both square and radius Din locks | <b>12535</b>  | IP.DL           | 100     |

| Description   | Diameter | Finish          | Re-order Code | Product Code  | Box Qty |
|---|----------|-----------------|---------------|---------------|---------|
| <b>Handles</b>  |          |                 |               |               |         |
|  Return to Door Lever Handle | 19mm     | Stainless Steel | <b>50357</b>  | RL.RTD.121.SS | 20      |
|  T-Bar Lever Handle          | 19mm     | Stainless Steel |               | RL.STB.135.SS | 20      |
|  Mitred Lever Handle         | 19mm     | Stainless Steel |               | RL.M.125.SS   | 20      |

| Description   | Finish  | Re-order Code | Product Code   | Box Qty |
|---|---|---------------|----------------|---------|
| <b>Dog Bolt Hinge</b>   |   |               |                |         |
|  Dog Bolt Security Hinge | Stainless Steel - Square  | <b>50339</b>  | RH.DBSH.34.SSS | 40      |
|   | Stainless Steel - Radius  | <b>50340</b>  | RH.DBSH.34.SSR | 40      |
|   | Hinge Pad Intumescent Kit for 102x76mm Square or Radius (Singles) | <b>12682</b>  | IP.HP43        | 500     |



GIVING YOU PEACE-OF-MIND

# Testing & Certification

With the mission to enhance life safety at every fire door, Rutland invest heavily in third-party certification to assist principal designers, principal contractors and accountable person's making informed decisions to meet Building Regulations.

We believe that every building should protect the life within, and from concept of the 'golden thread' of building safety information, Rutland have avidly supported and promoted an ever-growing online compliance data in digital format. Rutland website contains information on important regulations, product standards and regular webinars on current topical issues affecting fire door safety – all of which can be used as training for increased competency.





## BS EN 1154 & BS EN 1155 – DOOR CLOSER Standards Explained

### BS EN 1154: Controlled Door Closing Devices

This provides details on product types, classification by use, test cycles through to door mass and corrosion resistance. It also includes definitions, product performance requirements, test apparatus, test methods and marking of products.

#### CLASSIFICATION

A 6-digit coding system is used.

#### Classification Digit 1 – Category of use

For all internal and external doors for use by the public, and others, with little incentive to take care, i.e. where there is some chance of misuse of the door<sup>2</sup>.

- grade 3: For closing doors from at least 105° open
- grade 4: For closing doors from 180° open<sup>1</sup>

Note 1: For applications subject to extremes of abuse, or for particular limitations of opening angle, door closers incorporating a backcheck function or provision of a separate door stop should be considered.

Note 2: Grade 4 classification assumes standard installation according to the manufacturer's instructions.

#### Classification Digit 2 – Number of test cycles

Only one test duration is identified for door closers:

- grade 8: 500,000 test cycles

#### Classification Digit 3 – Test door mass/size

Seven test door mass grades and power sizes from EN 1 to EN 7 are identified in table 1 of this standard. Where a door closer provides a range of power sizes both the minimum and the maximum sizes are identified e.g. 2/5

#### Classification Digit 4 – Fire behaviour

Two grades of fire behaviour are identified for door closing devices manufactured to this standard:

- grade 0: Not suitable for use on fire/smoke door assemblies
- grade 1: Suitable for use on fire/smoke door assemblies, subject to satisfactory assessment of the contribution of the door closer to the fire resistance of specified fire/smoke assemblies. Such assessment is outside the scope of this European Standard (see EN 1634-1).

#### Classification Digit 5 – Safety

All door closers are required to satisfy the Essential Requirement of safety in use. Therefore only grade 1 is identified.

#### Classification Digit 6 – Corrosion resistance

Door closer are corrosion tested to EN 1670 and given a grade from no resistance of 0 to Very high resistance at grade 4:

- grade 0: No defined corrosion resistance
- grade 1: Mild resistance
- grade 2: Moderate resistance
- grade 3: High resistance
- grade 4: Very high resistance

#### CE/UKCA marking

Door closers intended for use on fire resisting doors and smoke control doors are covered by a Construction Products Directive mandate issued by the European Commission. Consequently, this standard is regarded as a "harmonised" standard and compliance with it, supported by suitable evidence, allows the application of the CE mark. It has also been adopted by the UK as a "designated" standard for UKCA marking.

#### BS EN 1155 – Electrically powered hold-open devices for swing doors

The standard provides details on product types, classification by use, test cycles, door mass, corrosion resistance, as well as definitions, product performance requirements, test apparatus, test methods and marking of products. In addition, the published standard includes annexes illustrating the various points made through diagrams and supplementary text.

#### SCOPE

This European standard specifies requirements for separate hold-open devices and also for holdopen mechanisms incorporated in a door closer. Electrically powered hold-open devices for swing doors manufactured according to this European standard can hold a swing door at a fixed position or can allow the door to swing freely. In each case interruption of the electrical supply will cause the controlled door to close positively.

Electrically powered hold-open devices manufactured in accordance with this European standard are recommended for use wherever there is a requirement for reliable hold-open and release of self-closing fire/smoke door assemblies. Whilst these devices can incorporate smoke or fire detection elements, the performance of those particular elements is outside the scope of this European standard.

#### CLASSIFICATION

BS EN 1155 classification is the same 6 digit coding system, taken from the BS EN 1154 testing standard.

#### Digit 1 – Category of use

Only one category of use is identified for electrically powered hold-open devices. – grade 3: for doors for use by the public, and others, with little incentive to take care, i.e. where there is some chance of misuse of the door.

Note: for electrically powered hold-open and free-swing door closers, where the opening angle is limited by the device, provision of a separate door stop should be considered.

#### Digit 2 – Number of test cycles

Two test duration are identified for devices manufactured to this European standard:

- grade 5: 50 000 test cycles. For all electrically powered hold-open devices
- grade 8: 500 000 test cycles. For all electrically powered hold-open and free-swing door closers and devices that contain operating arms.

#### Digit 3 – Test door mass

Five door mass grades and related hold-open power sizes are identified according to Table 1 of this European standard.

Where an electrically powered hold-open device is suitable for a range of door closer power sizes, both the minimum and maximum power sizes shall be shown.

#### Digit 4 – Fire resistance

Only one grade of fire resistance is identified for electrically powered hold-open devices manufactured to this European standard:

- grade 1: Suitable for use on fire/smoke door assemblies subject to satisfactory assessment of the contribution of the electrically powered hold-open device to the fire resistance of specified fire/smoke door assemblies. Such assessment is outside the scope of this European standard (see EN 1634-1).

#### Digit 5 – Safety

Electrically powered hold-open devices are required to satisfy the Essential Requirement of safety in use. Therefore only grade 1 is identified.

#### Digit 6 – Corrosion resistance

Five grades of corrosion resistance are identified in accordance with EN 1670:

- grade 0: no defined corrosion resistance.
- grade 1: mild resistance.
- grade 2: moderate resistance.
- grade 3: high resistance.
- grade 4: very high resistance.

**This page is not intended to be the full representation of the standards, and it is recommended you purchase your own copies from BSI.**

KEEPING YOU UPDATED

# Latest Topics

Challenges faced by contractors such as new air circulation systems preventing doors closing, through to tight door gaps with excessive smoke seals impeding a door closing ability. Airlocks and airtight buildings can impede doors closing safely, especially if the wrong door closer is used.

Door control questions are regularly answered on the news section in Rutland's website.

Recent subjects have included:



## Why do door closers go down to EN2 when EN3 is the legislated minimum?

In this post understanding the BS EN 1154 recommending door closers on fire doors being a minimum EN3 power size is discussed, and why many top contractors are choosing a power adjustable 2-4 or 2-5 door closer...<https://www.rutlanduk.co.uk/why-do-door-closers-go-down-to-en2-when-en3-is-the-legislated-minimum>



## What's the quickest way to increase the scope of my existing PAS 24 / dual-certified doorset?

In this article, we look at a few areas to consider when seeking to extend the scope of a dual-certified doorset, and how this can process can be achieved most efficiently, without cutting corners in life safety. <https://www.rutlanduk.co.uk/what-to-do-when-certification-not-accepted>

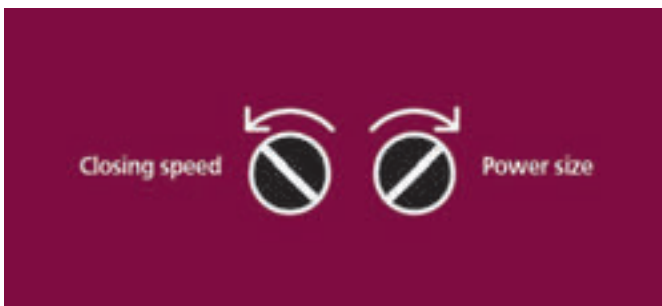

## How do we adjust door closers to overcome air pressures?

When a door closes, air needs to escape or equalise. When air pressures are high, the door needs to close more slowly but with more force. Doors, therefore, need to be adjusted accordingly to increase power & decrease speed...in this post we explain how small adjustments can make a big difference.



## Danger of value engineering affecting life safety

Here the danger of value engineering is warned against, especially when life safety is at stake. 'Race to the bottom', ignoring the value of correct testing and certification can result in serious consequences. In Rutland's opinion, life is too precious to drive its value down through commercial processes. Read the full post on website news section...<https://www.rutlanduk.co.uk/danger-of-value-engineering-affecting-life-safety>

KEEPING YOU UPDATED

# EVENTS

To watch the recordings of our webinars, please head over to the events page on our website: [www.rutlanduk.co.uk/events](http://www.rutlanduk.co.uk/events)

WEBINAR SERIES

How accountable is 'Accountable' within the Golden Thread?



WEBINAR SERIES

Ensuring a commercially sustainable future in Door Manufacturing



WEBINAR

Third-Party Certification Explained



PODINAR EVENTS

Covid ventilation vs keeping fire doors closed



WEBINAR

Dual Certification Unravelling



WEBINAR

Optimising Smoke Control



## DOOR CLOSER GUIDANCE

# Fixing Positions

### Figure 1: Standard Fixing

A standard fit where the closer is fitted to the pull side of the door.

### Figure 61: Transom Fixing

A transom mounting where the closer is fitted to the door frame.

### Figure 66: Parallel arm Fixing

Where the closer is fitted to the push side with a parallel arm bracket.

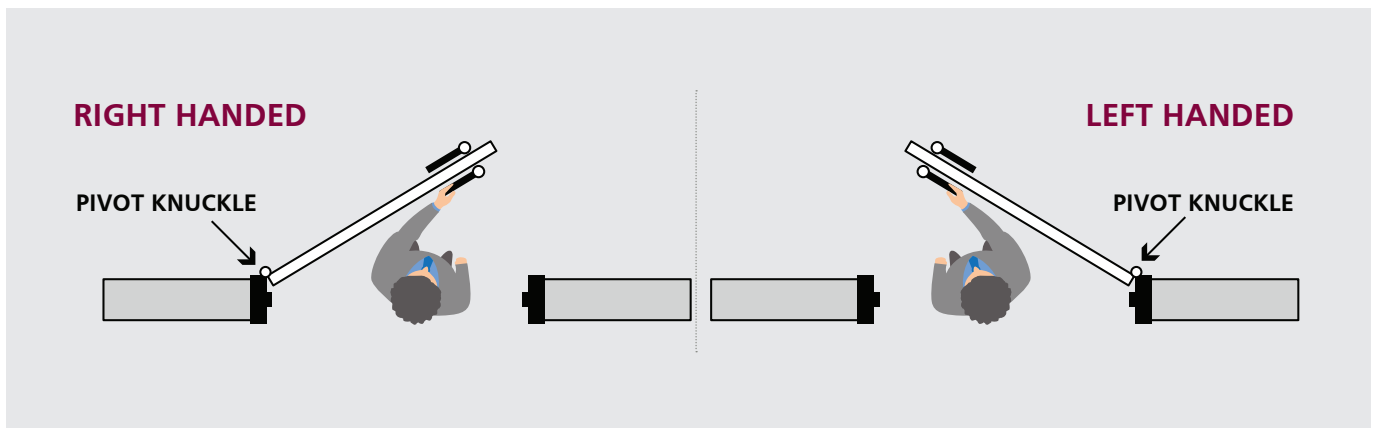

## Handing

There are various opinions amongst hardware manufacturers and door manufacturers on the handing of a door and hardware. To make it easy, Rutland have chosen the method whereby if you are on the side of the door where you can see the hinge knuckle, if the hinge knuckle is on your left, the door is left handed, and if the hinge knuckle is on your right it is a right handed door.

## DOOR CLOSER GUIDANCE

# Typical Standard Arm Installation Details

**Figure 1 - Standard**

For fixing pull side of the door.

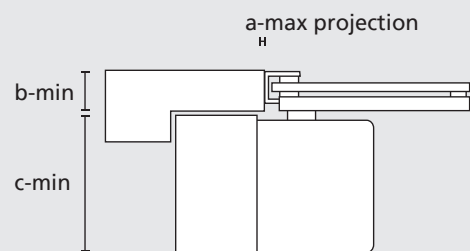
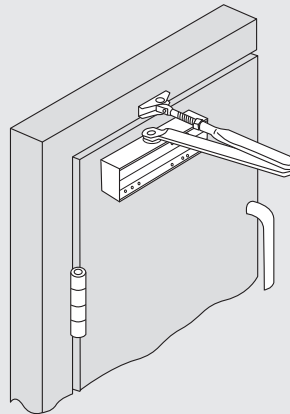

**Figure 66**

For fixing push side of the door.

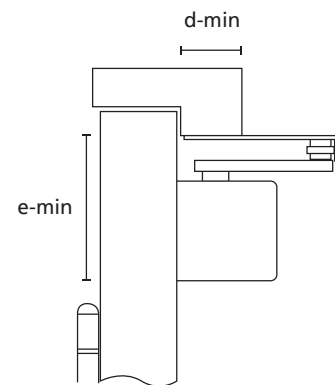
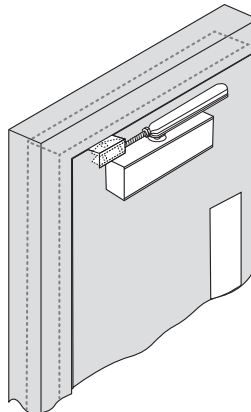

**Figure 61**

For fixing to transom on push side of the door.

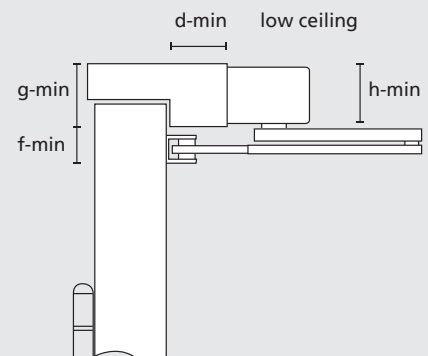
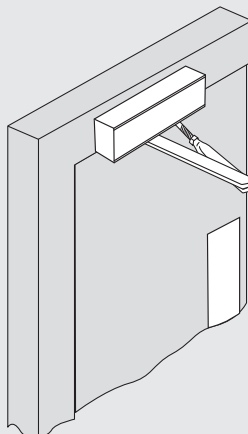

Fixings and fixing instructions are supplied in each pack.



DOOR CLOSER GUIDANCE

# How do I know my door closer will assist BS 8300?

As a designer and manufacturer of door closers, you might think that we'd only be concerned about the forces required to close a door. But the force applied to close a door corresponds directly to the force required to open that door. And whilst fire safety regulations dictate that fire doors must close completely and reliably, Equality legislation protecting the physically impaired demands that spaces are universally accessible. This means that choosing the correct door closer can often be a balancing act between allowing ease of opening and ensuring reliable closing.

In juggling these competing priorities, our customers often come to us and ask: How can I be sure that the door closer I order will comply with BS 8300 regulations in situ? This is particularly challenging because until the door and its closer are installed, it is difficult to assess exactly what closing force will be required and what the corresponding opening force will therefore be.

**Door opening requirements**

British standard BS 8300-2:2018, in tandem with Doc M, provides practical guidance on how to meet the minimum standards required to comply with the Equality Act.: "...a door closer must produce an opening force of below 30N between 0° and 30° degrees and below 22.5N between 30° and 60° degrees...". With this guidance in mind, we are often asked what power door closer do I need for a 60kg door to comply with BS 8300 requirements? Sadly, the answer is, it's not that simple but in this blog we explore how you can make an educated estimate whilst making provisions for other factors that come into play once on site.

**Weight is only one factor**

Whilst it is impossible to accurately predict the eventual opening force of the door once installed, there are reasonable steps you can take to ensure that the final opening force of the door is enough to comply with the Equality Act and ensure that those who are physically impaired can still access facilities easily.

Whilst weight is a key factor that will inform which door closer you choose, it is not the only one. Physics dictates that it is the weight combined with the width that dictates the starting point for your choice of door closer. For instance, a very wide 40kg door is a lot easier to open at the leading edge than a very narrow 40kg door.

**A starting point**

It is possible to estimate the power size required by looking at the weight and width of the door. The table below is a good place to start when choosing a door closer.

| Power size (EN) | Max door weight (kg) | Max door width (mm) |
|-----------------|----------------------|---------------------|
| 1               | 20                   | 750                 |
| 2               | 40                   | 850                 |
| 3               | 60                   | 950                 |
| 4               | 80                   | 1100                |
| 5               | 100                  | 1250                |
| 6               | 120                  | 1400                |

\*An abridged table based on guidance given in BS 1154

Do bear in mind that guidance states that fire doors should be fitted with EN 3 door closers as a minimum.

**Other factors to consider**

Of course we all know that when installing a door on-site, other factors come into play which often impact on door opening/closing forces: air pressures in the rooms on each side of the doorway, whether or not door seals are fitted, the quality of door hardware used, and potentially other factors. Therefore, a door closer will often need adjusting once the doorset has been installed.

**Rutland recommendation**

In conclusion, it is entirely legitimate to be uncertain as to whether a door closer will assist with BS 8300 regulations or not (whilst also adhering to fire regulations), because it is impossible to predict all the contributing factors in the eventual environment. For this reason, we recommend making an estimate using the weight and width of the door and then using an adjustable closer, such as the TS.11204, that covers a power above and below the expected power required, in order to balance the competing demands of sufficient closing power and the correct ease of opening.

DOOR CLOSER GUIDANCE

# Door width sizing guide

| Minimum Door Widths |              |                 |              |                 |
|---------------------|--------------|-----------------|--------------|-----------------|
| Door Closer         | Pull Side    |                 | Push Side    |                 |
|                     | Door Mounted | Transom Mounted | Door Mounted | Transom Mounted |
| TS.3204             | 300mm        | -               | 470mm        | 300mm           |
| TS.4204             | 340mm        | -               | 485mm        | 340mm           |
| TS.5204             | 360mm        | -               | 485mm        | 360mm           |
| TS.9205             | 390mm        | -               | 470mm        | 390mm           |
| TS.9206             | 415mm        | -               | 490mm        | 415mm           |
| TS.10106            | 330mm        | -               | 535mm        | 330mm           |
| TS.24               | 490mm        | 490mm           | -            | 515mm           |
| TS.11204            | 575mm        | 575mm           | 575mm        | 575mm           |
| TS.11205            | 575mm        | 575mm           | 575mm        | 575mm           |
| ITS.11204           | 595mm        | 595mm           | 595mm        | 595mm           |
| ITS.11205           | 595mm        | 595mm           | 595mm        | 595mm           |
| ETS.18314           | 385mm        | -               | 502mm        | -               |
| TS.FIRETRAK         | 600mm        | 600mm           | 615mm        | 600mm           |

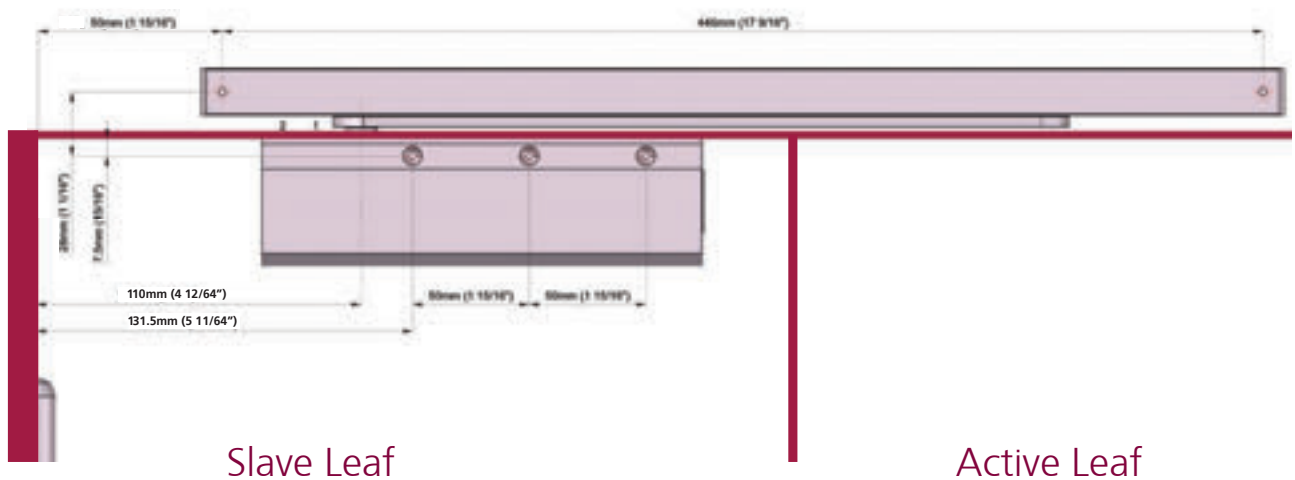

The minimum width for the slave leaf is 360mm, in this case the minimum width for the active leaf would need to be 780mm – the total width between the two leaf’s can not be less than 1140mm.

MAKING THE RIGHT CHOICE

# Colour / Finish



**Silver**

| UK | US | BHMA |
|----|----|------|
| SE | 2G | 603  |



**Satin Nickel Plate**

| UK  | US   | BHMA |
|-----|------|------|
| SNP | US15 | 646  |



**Polished Nickel Plate**

| UK  | US   | BHMA |
|-----|------|------|
| PNP | US14 | 645  |



**Polished Brass**

| UK  | US  | BHMA |
|-----|-----|------|
| PVD | SP4 | 706  |



**Satin Stainless Steel**

| UK  | US    | BHMA |
|-----|-------|------|
| SSS | US32D | 630  |



**Polished Stainless**

| UK  | US   | BHMA |
|-----|------|------|
| PSS | US32 | 629  |



**Black**

| UK | US    | BHMA |
|----|-------|------|
| BK | SPBLK | 693  |



**Antique Copper**

| UK | US | BHMA |
|----|----|------|
| AC | -  | 657  |



**Antique Brass**

| UK | US  | BHMA |
|----|-----|------|
| AB | US7 | 636  |



**Satin Brass**

| UK | US  | BHMA |
|----|-----|------|
| SB | US4 | 633  |



**Light Bronze**

| UK | US   | BHMA |
|----|------|------|
| LB | US13 | 656  |



**Medium Bronze**

| UK | US | BHMA |
|----|----|------|
| MB | -  | 694  |



**Dark Bronze**

| UK | US   | BHMA |
|----|------|------|
| DB | US11 | 617  |



**Weathered Bronze**

| UK | US   | BHMA |
|----|------|------|
| WB | US26 | 625  |



MAKING THE RIGHT CHOICE

# Design Style

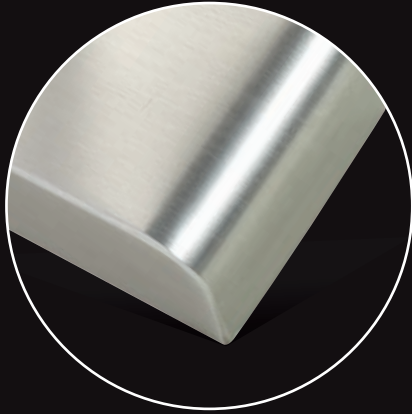

Semi Radius Cover

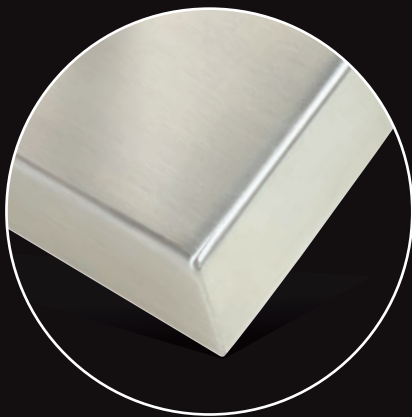

Square Edged Cover

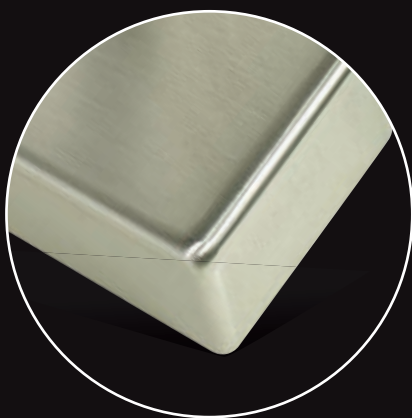

Soft Line Cover

Soft Line; Square Edge  
or Semi Radius covers

Rutland understands the need of variety. Our product range gives you a wide choice of options, different styles, shapes, and colours providing the changing image to the architecture of any building.

For the latest trends, designs and styles please visit our website – [www.rutlanduk.co.uk](http://www.rutlanduk.co.uk)



## MAKING THE RIGHT CHOICE

# FAQs

### Can I use Rutland door closers externally?

Yes, if not exposed to the elements (weather, rain, snow, salt water spray etc). Each Rutland CE Certificate shows classification for corrosion resistance in box 6. For external use where exposed to the weather use a grade 4 door closer, which is for high resistance.

### What is Back Check?

Back check provides a cushioning effect when a door is forcibly thrown open. It is not a substitute for a doorstop.

### What is Delayed Action?

Delayed action prolongs closing time, for example to make it easier for wheelchairs or less able people to pass through the door easily. On a fire door this should be set to a max of 25 seconds delay from fully open to 70 degrees where the normal valves will take over. For the TS.9205 in figure 66, a star cut arm must be used to enable this to work.

### What is the British Standard BS 8300:2009+A1:2010?

It's the standard that covers the design of buildings and the approach to meeting the needs of people with disabilities. It's widely used as a reference document for guidance on issues not specifically covered in building regulations.

With regard to door closers, BS 8300 states: 'the opening force, when measured at the leading edge of the door, should be not more than 30 N from 0° (the door in the closed position) to 30° open, and not more than 22.5 N from 30° to 60° of the opening cycle.'

### My door closer doesn't work, what should I do?

If your door closer is not working and you're wondering what steps to take, we have a helpful blog on our website:

<https://www.rutlanduk.co.uk/door-closer-is-not-working> which takes you through the possible causes of your door closer not working. Alternatively, send us an email or give us a call, and our technical team will be more than happy to help!

### What do I do if I want to return some products?

Products can easily be returned if you follow the simple guidelines:

1. Confirm it is a Rutland product (\*Please note that bespoke colour finishes are not returnable)
2. Have the correct invoice that it was sold to yourselves on
3. Check the date it was despatched to yourselves
4. Contact Rutland and confirm reason for return
5. Collect a returns note from Rutland with the agreed credit if applicable – subject to inspection on return.
6. Pack product securely and Label with Rutland address.
7. Agree a date and time for Rutland to collect.
8. Please remember that goods will be credited if returned in a re-saleable condition and in perfect working order. Goods returned after 3 months may not be credited.

FIND US ON

# NBS Source



Rutland now have a range of products available to specify via the NBS Source portal.

NBS source is a specification tool that creates a single source for product information. With over 1,100 manufacturers, this platform provides architects, engineers and specifiers with ready to use product specifications and digital objects such as BIM files. The following Rutland products are currently listed on the NBS source platform, with Images, data sheets, certification and BIM files readily available:

TS.11204, TS.11205, ITS.11204, ITS.11205, TS.9205, TS.9206, TS.5204, TS.3204.

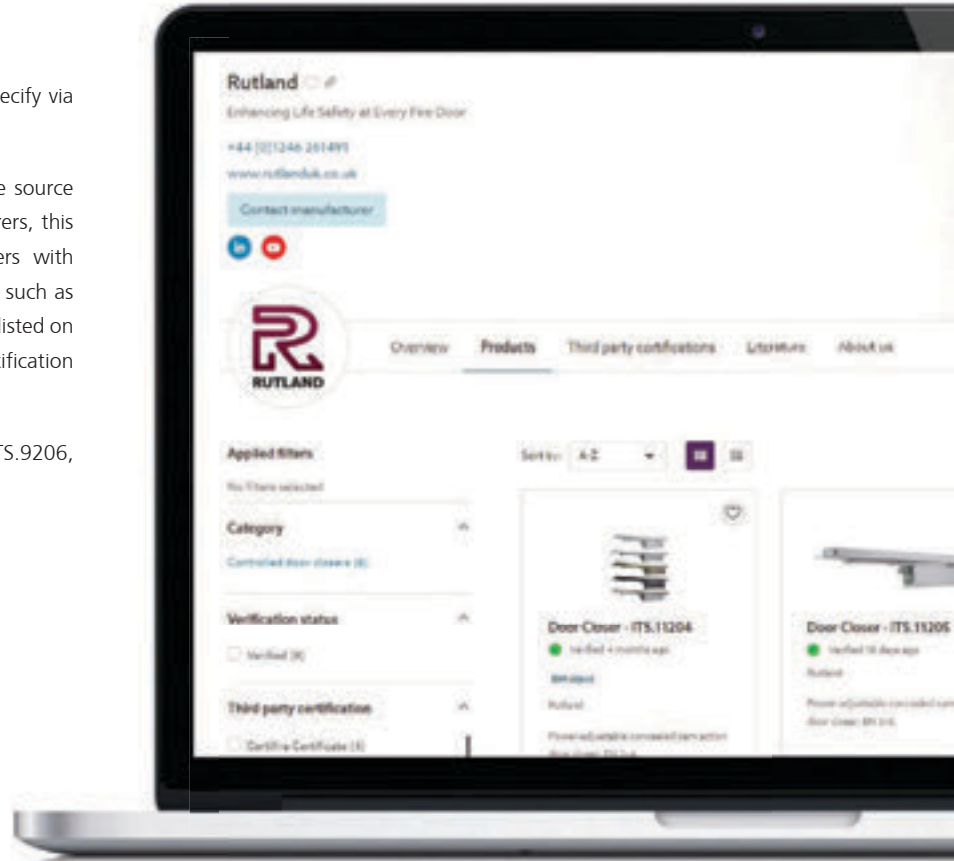

Check out the portal on the below link:



EARN CPD POINTS WITH OUR

# RIBA Approved CPD



Rutland offers a RIBA approved CPD titled 'Design Considerations for Fire Door Control and Understanding Today's Fire Door Challenges'.

This seminar can be scheduled as an online or in-person CPD via the RIBA website by scanning



Alternative training courses and CPD's are also available upon request, including our Door Closer installer training course.







# Contact us

---

WE'RE HERE TO PROVIDE AN  
EXCEPTIONAL EXPERIENCE

Once you have your REORDER CODE  
place your order via:

 [sales@rutlanduk.co.uk](mailto:sales@rutlanduk.co.uk)

 +44 (0)1246 261491

Tell us the quantity you require;  
Delivery address; **DONE!**

Using the REORDER CODES will ensure you  
receive the product you need every time!

# Enhancing life safety at every fire door

# Enhancing life safety at every fire door

Through our expert advice and support, we provide the peace of mind that full compliance is achieved and that life safety is assured.



**Head Office:**

Rutland Trading Co. Ltd.  
Whittington Way,  
Chesterfield, S41 9AG

**Contact us:**

+44 (0)1246 261491  
sales@rutlanduk.co.uk  
rutlanduk.co.uk